

BCS220 BLOWDOWN CONTROLLER

INSTALLATION AND MAINTENANCE INSTRUCTIONS



GENERAL INFORMATION

- These instructions must be carefully read before performing any work involving VALSTEAM ADCA products. Failure to observe these instructions may result in hazardous situations.
- These instructions describe the entire life cycle of the product. Keep them in a location that is accessible to every user and make these instructions available to every new owner of the product.
- Current regional and plant safety regulations must be considered and followed during installation, operation, and maintenance work.
- The images shown in these instructions are for illustration purposes only.
- For the problems that cannot be solved with the help of these instructions, please contact VALSTEAM ADCA or its representative.

VALSTEAM ADCA ENGINEERING S.A

Zona Ind.da Guia
Pav.14 - Brejo
3105-467 Guia, Pombal
PORTUGAL
quality@valsteam.com

We reserve the right to change the design and material of this product without notice.

CONTENT

1. SAFETY INFORMATION	5
1.1. Explanation of symbols	5
1.2. Intended use	5
1.3. Qualification of personnel	6
1.4. Personal protective equipment	6
1.5. The system	6
1.6. ATEX	6
1.7. General safety notes	7
2. PRODUCT INFORMATION	7
2.1. Certification	9
2.2. Product identification	9
2.4. Technical data	9
3. TRANSPORT, STORAGE AND PACKAGING	10
4. INSTALLATION	10
4.1. Preparation for installation	11
4.2. Mechanical installation procedure	11
4.2.1 Mounting the controller onto a surface or wall	12
4.2.2. Mounting the controller onto a panel	13
4.2.3. Mounting the controller onto a pipe	14
4.3. Electrical installation	14
4.3.1 Terminal operation	15
4.3.2. Connecting the supply voltage	15
4.3.3. Connecting the relay outputs	16
4.3.4. Connecting the conductivity probe	19
4.3.5. Connecting the temperature sensor	20
4.3.6. Connecting the analog output	20
4.3.7. Connecting the digital input	21
4.4. Using the MicroSD card interface	21
5. COMMISSIONING	22
5.1. Security access code	23
5.2. Conductivity input setup	24
5.3. Calibration	29
5.4. Configuring the setpoint functions	33
5.4.1. Setpoint proportional mode	41
5.5. Configuring the 0(4) to 20 mA analog output functions	43
5.6. Configuring the digital input functions	46
5.7. Configuring the basic operating parameters	48
5.8. Updating the software version	50
5.9. Save, restore and factory reset	51

CONTENT

5.10. Service	52
5.11. Commissioning examples	53
6. TROUBLESHOOTING	55
7. DISPOSAL	59
8. RETURNING PRODUCTS	59

1. SAFETY INFORMATION

1.1. Explanation of symbols



DANGER

Hazardous situation which, if not avoided by applying the correct preventive measures, will result in fatal or serious injury and/or considerable damage to property.



WARNING

Hazardous situation which, if not avoided by applying the correct preventive measures, could result in fatal or serious injury and/or considerable damage to property.



CAUTION

Hazardous situation which, if not avoided by applying the correct preventive measures, could result in moderately severe or minor injury.



NOTICE

Situation which, if not avoided, can result in property damage or product malfunction.



NOTE

Indicates additional information, tips and recommendations.

1.2. Intended use

Refer to the markings on the product, such as nameplate, Information Sheet (IS) and these Installation and Maintenance Instructions (IMI) to check that the product was designed for the intended use and meets the specifications used for selection.

VALSTEAM ADCA does not assume any responsibility for damage resulting from inappropriate use of the product, damage caused by external stresses or any other external factors. Correct installation and use of the product is of the full responsibility of the contractor.

Inappropriate use of the product is any use other than the one described in this chapter.

Inappropriate use also includes:

- Use outside the limits defined by the product.
- Unauthorized modifications to the product.

If the product is to be used for an application other than the one it was designed for, contact VALSTEAM ADCA.

1.3. Qualification of personnel

Handling, installation, operation and maintenance work must be carried out by fully trained and qualified personnel, capable of judging the work which they are assigned to perform and recognizing potentially hazardous situations. They should be trained to properly use this product according to these Installation and Maintenance Instructions.

Where a formal “Permits to Work” system is implemented in the plant it must be complied with.

1.4. Personal protective equipment

Personal protective equipment should always be worn during work in order to protect against hazards posed by e.g. the process medium, dangerous temperatures, noise, falling or projected objects, working at height. These equipment includes a helmet, safety glasses, safety harness, protective clothes, safety shoes, hearing protection, etc.

NOTE

Always assess whether you or others in your vicinity require any protective equipment. When in doubt check with the plant’s health & safety responsible personnel for details on required protective equipment.

1.5. The system

The complete system should be assessed as well as every action (e.g. closing of shut-off valves, disconnection of the power supply) to ensure this will not bring additional risk to personnel or property.

Dangerous actions that can result in a hazardous situation include isolation of protective devices such as safety valve, vents, vacuum relief valves, disconnection of electric safety devices, sensors and alarms.

1.6. ATEX

If the product is in the scope of the ATEX 2014/34/EU directive and as such bears the Ex marking, consult its specific Additional Instructions for use in Potentially Explosive Areas (IMI EX). In such cases, handling, installation, operation and maintenance work must

only be performed by personnel qualified and authorized to work in potentially explosive areas.

1.7. General safety notes



DANGER

RISK OF ELECTRIC SHOCK

Before connecting wiring, opening or performing any work on the instrument, disconnect the supply voltage and protect it against unintentional reconnection.

- Do not perform work on live parts.
- Only use power interruption devices that are protected against unintentional reconnection of the power supply.
- An earth connection must be made to the earth terminal of the instrument.



NOTICE

RISK OF PRODUCT DAMAGE AS RESULT OF ILLEGIBLE INFORMATION

Important information written in the instrument nameplate. Markings and warning signs may wear overtime or get illegible due to e.g. dirt accumulation.

- Keep nameplates, markings and warning signs in a legible state, replacing when illegible, missing or damaged.

2. PRODUCT INFORMATION

The ADCATrol BCS220 is a blowdown controller specially designed for use with steam boilers. The instrument takes care of both TDS and intermittent blowdown controls. TDS (Total Dissolved Solids) is controlled through measurement of the boiler water electrical conductivity and intermittent control is performed via a blowdown timer. It may also be used for conductivity monitorization and control in feedwater tanks, contamination detection in condensate lines amongst many other applications.

The controller is suitable for use with ADCATrol SPS series conductivity probes as well as many other conductivity probes on the market. A Pt100 or Pt1000 temperature sensor can be connected to the controller to display, e.g. boiler water temperature, and to provide automatic temperature compensation of conductivity.

The instrument utilizes a clear multifunction LCD to display measured conductivity, temperature, operational alarm status and provide an intuitive user interface. The controller is IP 66 rated NEMA 4X and is prepared as standard to be wall mounted. However with the addition of a suitable mounting kit it can also be panel or pipe mounted.

The controller includes two volt free normally-open relay outputs. One of them is typically set to activate if the conductivity is above or below the setpoint, for boiler TDS control, and the other with an intermittent blowdown timer function. Other setpoint functions include time and pulse proportional and delayed activation.

Additionally, the controller features an isolated 0(4) to 20mA analog output that features adjustable scaling, selectable on-error states and loop fault detection. The analog output allows the instrument to transmit the primary reading or observed process temperature for remote monitoring purposes.

Also fitted is a single contact digital input which allows the instrument to be remotely set to an an offline state that forces the relays to deactivate and the analog output to a pre-defined state. This setting can be used to de-activate the blowdown system during stand-by operations or when the burner is switched off, avoiding energy waste. The binary input can also be programmed to change the whole configuration of the instrument by switching the setup to a preconfigured state.

Depending on the model the controller is powered by either 90 to 265 V AC (ADCATrol BCS220) or 12 to 30 V DC (ADCATrol BCS220-LV).

CONDUCTIVITY RANGE	NOMINAL CELL CONSTANT			
	0,01	0,1	1	10
0 to 9,999 μ S/cm	•	•		
0 to 99,99 μ S/cm	•	•	•	
0 to 999,9 μ S/cm		•	•	•
0 to 9999 μ S/cm *			•	•
0 to 9,999 mS/cm			•	•
0 to 99,99 mS/cm **			•	•
0 to 999,9 mS/cm **				•

* Range is only available as a fixed range. ** Maximum measured range is limited by the solution temperature.

RESISTIVITY RANGE	NOMINAL CELL CONSTANT			
	0,01	0,1	1	10
0 to 99,99 k Ω .cm		•	•	
0 to 999,9 k Ω .cm	•	•		
0 to 9,999 M Ω .cm	•	•		
0 to 99,99 M Ω .cm	•			

TOTAL DISSOLVED SOLIDS RANGE	NOMINAL CELL CONSTANT			
	0,01	0,1	1	10
0 to 9,999 ppm	•	•		
0 to 99,99 ppm	•	•	•	
0 to 999,9 ppm		•	•	•
0 to 9999 ppm			•	•
0 to 99,99 ppt			•	•

Table 1 - Instrument range and sensor compatibility.

2.1. Certification

This instrument complies with the requirements of the European LVD - 2014/35/EU Low Voltage Directive, EMC - 2014/30/EU Electromagnetic Compatibility Directive and RoHS - 2011/65/EU Restriction of Hazardous Substances Directive.

2.2. Product identification

The following items are indicated on the product nameplate:

- Manufacturer
- Product model (e.g. BCS220-LV)
- Power supply (e.g. 12-30 V DC)
- IP rating (e.g. IP 66)
- Serial number and year of manufacturing (e.g. Reg.:17483/19)
- CE Marking (see section 2.2 – Certification)

2.4. Technical data

For technical data including dimensions, materials, limiting conditions and specifications refer to the product respective Information Sheet (IS).

3. TRANSPORT, STORAGE AND PACKAGING



NOTICE

RISK OF PRODUCT DAMAGE DUE TO IMPROPER STORAGE

- Do not remove any packaging or protective covers until immediately before installation at the site.
- Store the product in a solid base in a dry, cool and dust-free environment.
- Until its installation, protect it from the weather, dirt, corrosive atmospheres and other harmful influences.

Products are individually wrapped in plastic film, thermo shrinkable plastic and/or stored in a cardboard box as they leave VALSTEAM ADCA. Avoid removing packaging and any protective cover until immediately before installing the product at the site.

Ensure the product is stored at a temperature of -20 to +55°C and relative humidity of 5 to 95% in a non-condensing environment.



NOTE

If the transport packaging has any shipping damage contact VALSTEAM ADCA or its representative.

Before storing and transporting the product protect it from impacts and mechanical damage.

4. INSTALLATION

Before performing any installation work, refer to section 1 – Safety information.



NOTICE

LOCAL WIRING AND SAFETY REGULATIONS SHOULD BE STRICTLY ADHERED TO WHEN INSTALLING THE PRODUCT

- Should these regulations conflict with the following instructions, contact VALSTEAM ADCA or its representative for advice.

The performance of the instrument is entirely dependant on its correct installation. For this reason, thoroughly read the following instructions before making any electrical connection to the unit.

4.1. Preparation for installation

Before installation, make sure the following conditions are met:

- The product is not damaged.
- All the necessary materials and tools are readily available during installation work.
- Ensure correct installation of the product. Safety may be compromised if the installation is not carried out as specified in these Installation and Maintenance Instructions (IMI).
- Referring to these Installation and Maintenance Instructions (IMI), Information Sheet (IS) and nameplate, check that the product is suitable for the intended installation – see section 1.2 – Intended use.
- Check voltage, frequency and electric cable section to make sure that the electrical supply meets the specifications stated on the product nameplate.
- When designing the system make sure the system will fail safe. This could include the provision of an additional monitoring device, depending upon the particular application and any consequences of an instrument or sensor failure.

4.2. Mechanical installation procedure

The ADCATrol BCS220 as standard is designed to be mounted on a wall or surface via the two holes located in the rear of the enclosure. Alternatively, it can be mounted to a panel or a pipe using optional mounting kits.

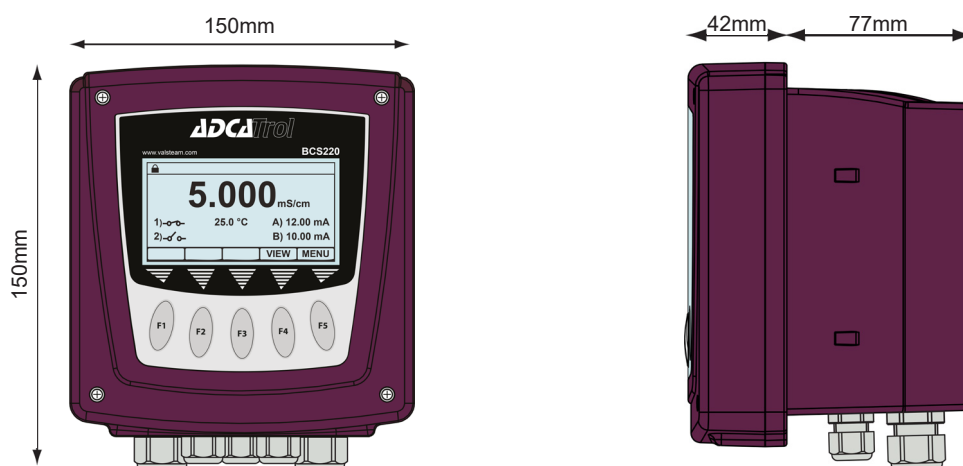
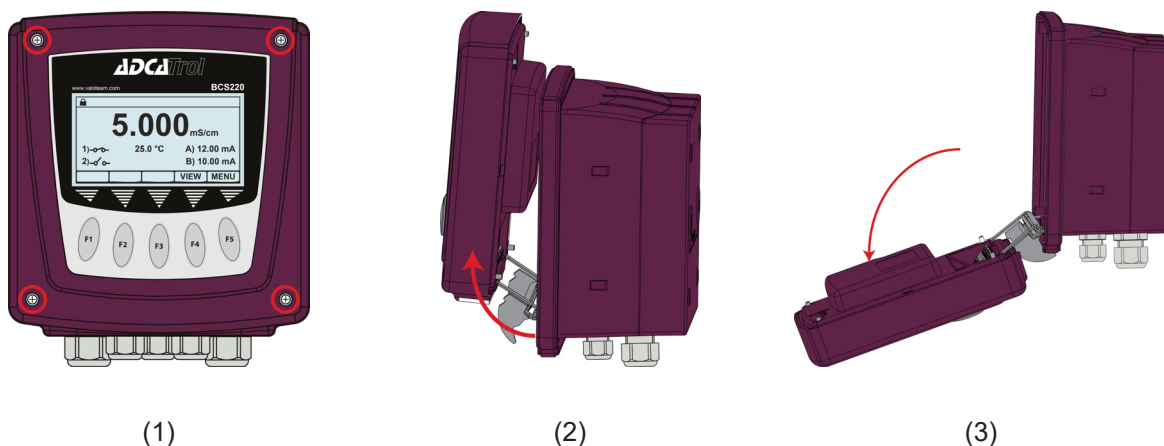

Fig. 2 - Enclosure overall dimensions.

The enclosure should be opened as follows:



1. Unscrew the four captive screws as highlighted.
2. Lift the front cover up and forward.
3. Rotate the front cover down until the hinge locks under the rear and front is supported.

To close the enclosure repeat the process above in reverse order, folding the hinge into the rear.

4.2.1 Mounting the controller onto a surface or wall

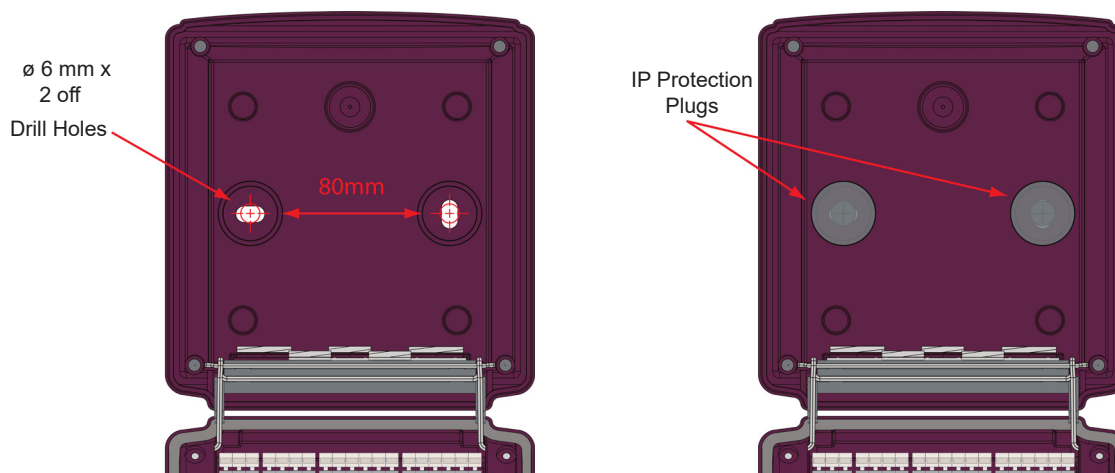

Fig. 3 - Enclosure rear cover.

1. Drill two $\text{Ø}6$ mm screw holes in the surface or wall where the controller is to be installed. The holes should be in the horizontal plane with distance of 80mm apart from each other, as shown above. Avoid fitting the controller in an uneven surface.
2. Mount the controller with 4,8 x 32 mm round head screws or similar.
3. Fit the accompanying IP protection plugs over the mounting holes on the inside rear of the enclosure.

4.2.2. Mounting the controller onto a panel

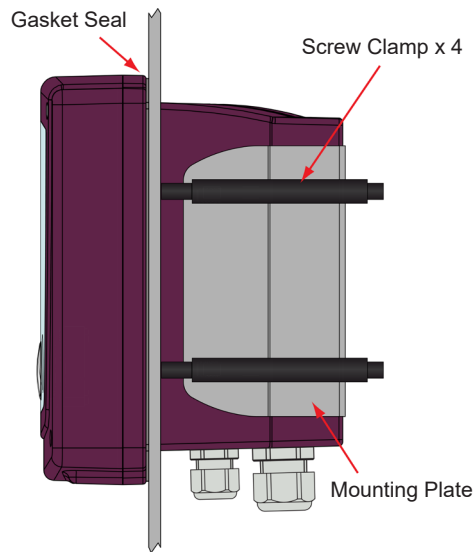

Fig. 4 - Panel mounting.



NOTICE

Keep the boiler control panel or enclosure door closed at all times unless installation work is being carried out.

1. Create a panel cutout with 138 x 138 mm.
2. Fit the gasket seal into the groove on the back of the controller front.
3. Attach the mounting plate to the rear of the controller with the supplied screws.
4. Remove cable glands and pass the controller rear through the panel cutout.
5. Use the 4 supplied screw clamps to affix it to the panel.

4.2.3. Mounting the controller onto a pipe

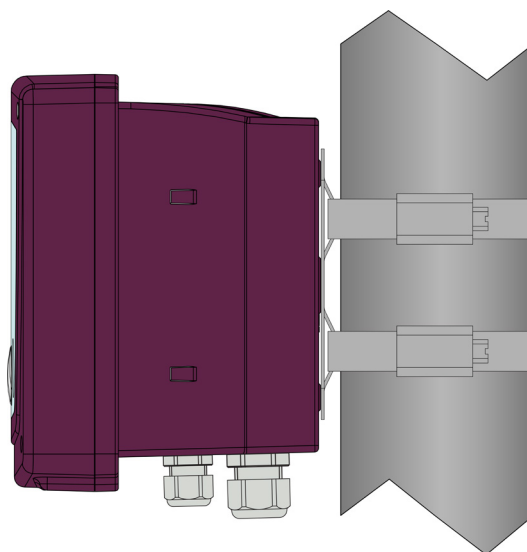

Fig. 5 - Pipe mounting.

1. The pipe mounting kit fits pipes from 50 to 100 mm OD.
2. Attach the mounting plate to the rear of the enclosure with the supplied screws.
3. Pass the supplied mounting straps through the plate loops and tighten the round pipe as required.
4. Fit the accompanying IP protection plugs over the internal mounting holes on the inside rear of the enclosure.

4.3. Electrical installation



NOTE

Electrification of the product should only be carried out by qualified and experienced personnel, and must comply with current regional electrical regulations and standards.

- Terminations at the connectors should not have any excess wire cut back so that a minimal amount of wire is left free to radiate electrical pick-up inside or close to the instrument housing.
- The cable connecting the conductivity probe to the controller must not be near motors, contactors, generators or wires carrying large currents.
- Cable screens should be connected as shown in order to comply with the electromagnetic compatibility requirements.
- The use of CE marked equipment to build a system does not necessarily mean that the system as a whole will comply with the requirements laid out by the EMC -

2014/30/EU Electromagnetic Compatibility Directive.

- If an interlock function is required for the installation it must be provided in the follow-up circuitry (safety circuit). The circuitry must meet the requirements of the EN 50156.

4.3.1 Terminal operation

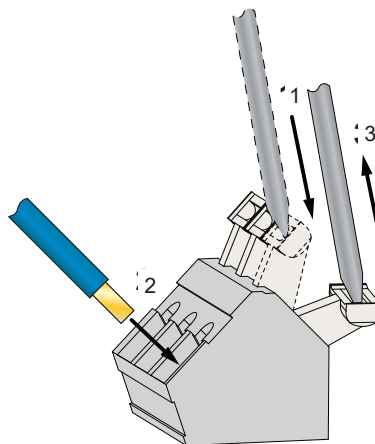

Fig. 6 - Terminal operation.

Whilst pushing the terminal lever down using a 3.5 mm slotted screwdriver, insert the wire into the opening and release the lever to hold in place.

4.3.2. Connecting the supply voltage

Depending on the model the controller is powered by either 90 to 265 V AC (ADCATrol BCS220) or 12 to 30 V DC (ADCATrol BCS220-LV). Refer to the nameplate on the instrument to confirm its input voltage limits. Exceeding these limits may permanently damage the instrument.

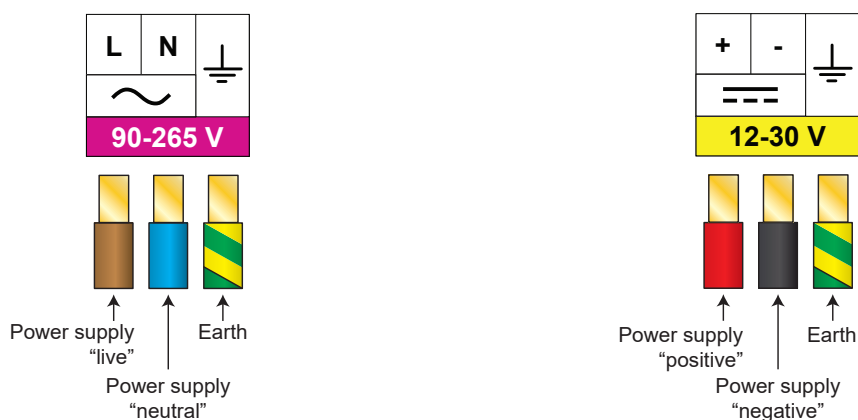

Fig. 7 - Supply voltage wiring diagram.

The power supply unit must be electrically isolated from dangerous contact voltages and must meet at least the requirements on double or reinforced isolation as stated in IEC 60364 or equivalent.

The power supply should be taken from an isolated spur and fused to a maximum of 3 Amps. The incoming Earth connection must be connected to the Earth terminal.

4.3.3. Connecting the relay outputs

The ADCATrol BCS220 is supplied with 2 normally-open volt free relay outputs designated with numbers 1 and 2. The relay contacts are connected to the terminals only and are electrically isolated from the instrument itself. These must be connected in series with a 5 Amp fuse. A contact arc suppressor may be required to prevent excessive electrical noise, depending upon the load. To switch more than 5 Amps will require a slave relay.

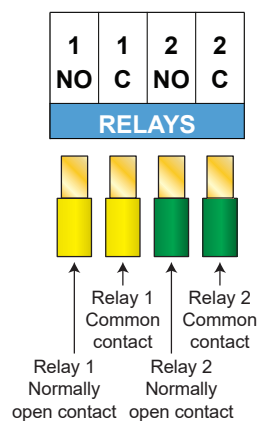

Fig. 8 - Relay output wiring diagram.

The relay outputs are typically used to signal the boiler blowdown valves to open or close. In these cases output 1 and 2 must connect to the boiler TDS blowdown valve and intermittent blowdown valve respectively.

The relay outputs may also be used for retransmission of alarms and signaling of other devices.

Wiring the ADCATrol VPC26 TDS blowdown valve

Following are a series of wiring diagrams that illustrate various connection options between the controller and a ADCATrol VPC26 TDS blowdown valve, according to valve configuration and wiring preference.

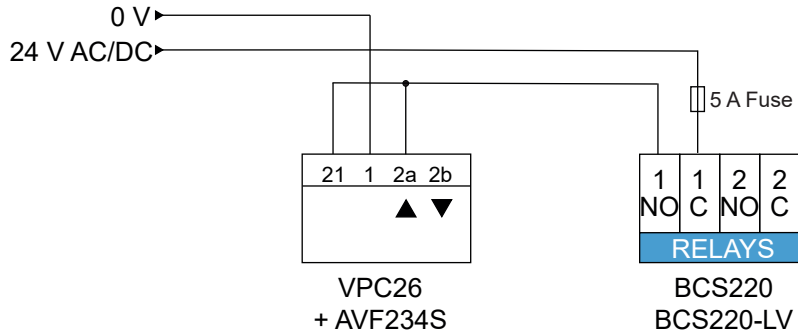

Fig. 9 - ADCATrol VPC26 fitted with AVF234S actuator, 24 V AC/DC supply, 2-point.

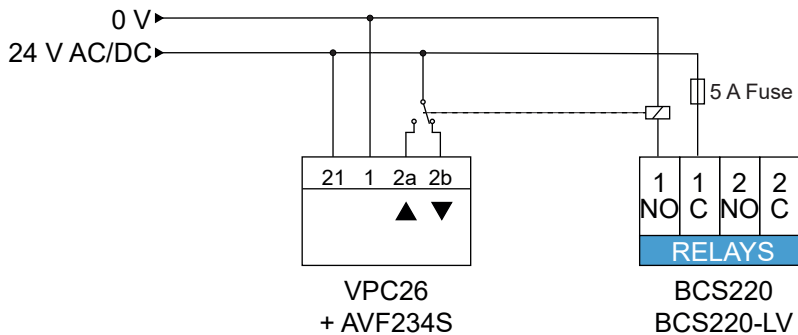

Fig. 10 - ADCATrol VPC26 fitted with AVF234S actuator, 24 V AC/DC supply, 3-point.

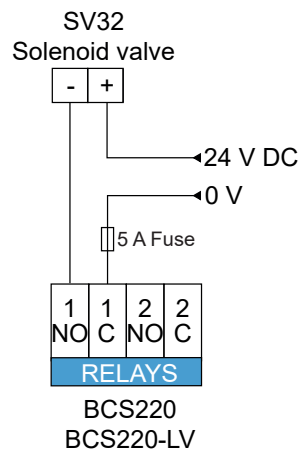

Fig. 11 - ADCATrol VPC26 fitted with reverse acting pneumatic actuator and SV32 solenoid valve, 24 V DC supply.

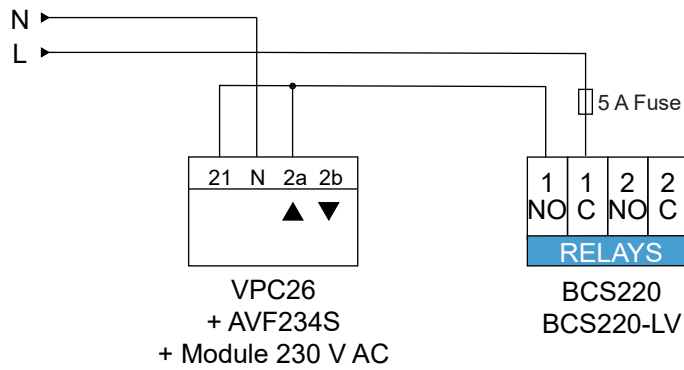

Fig. 12 - ADCATrol VPC26 fitted with AVF234S actuator, 230 V AC supply, 2-point.

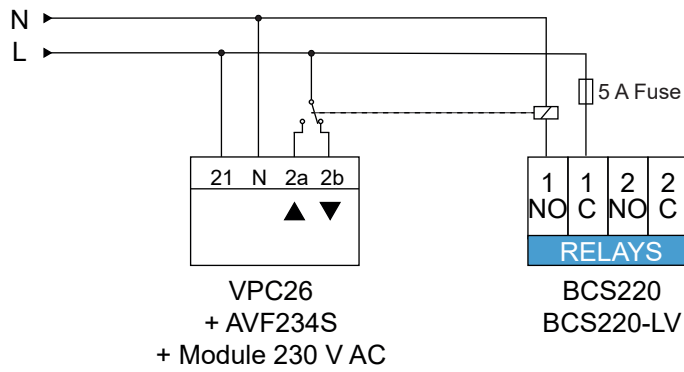

Fig. 13 - ADCATrol VPC26 fitted with AVF234S actuator, 230 V AC supply, 3-point.

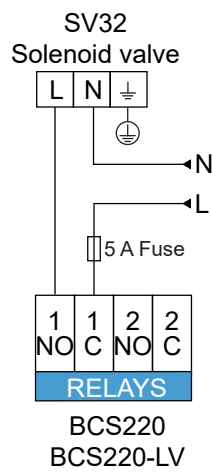

Fig. 14 - ADCATrol VPC26 fitted with reverse acting pneumatic actuator and SV32 solenoid valve.

Wiring the ADCATrol VPA26/2 intermittent blowdown valve

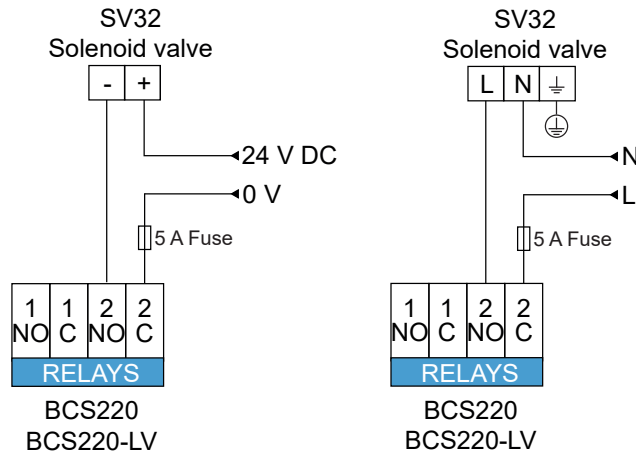

Fig. 15 - ADCATrol VPA26/2 fitted with reverse acting pneumatic actuator and SV32 solenoid valve.

4.3.4. Connecting the conductivity probe

The ADCATrol BCS220 is suitable for use with ADCATrol SPS series conductivity probes, as well as many other conductivity probes on the market.

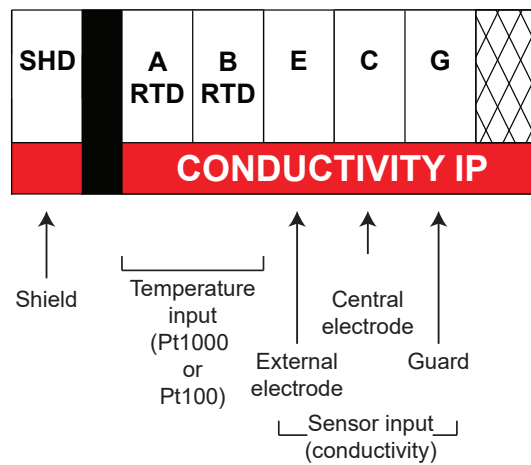

Fig. 16 - Conductivity probe input signal arrangement.

When connecting a ADCATrol SPS21 or SPS33 conductivity probe to the controller use a screened multi-core cable with a minimum wire size of 0,5 mm² such as a LiYCY 2 x 0,5 mm².

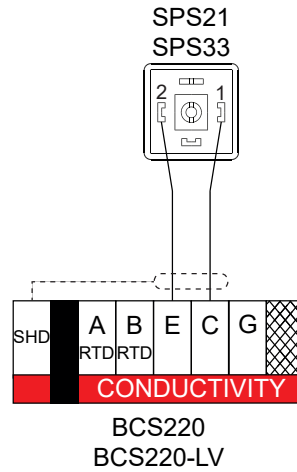

Fig. 17 - ADCATrol SPS21 and SPS33 conductivity probe wiring.

4.3.5. Connecting the temperature sensor

The ADCATrol BCS220 includes a temperature sensor input which is used e.g. to perform automatic temperature compensation of the conductivity reading. The controller accepts Pt100 and Pt1000 inputs with 2, 3 or 4 wire technology.

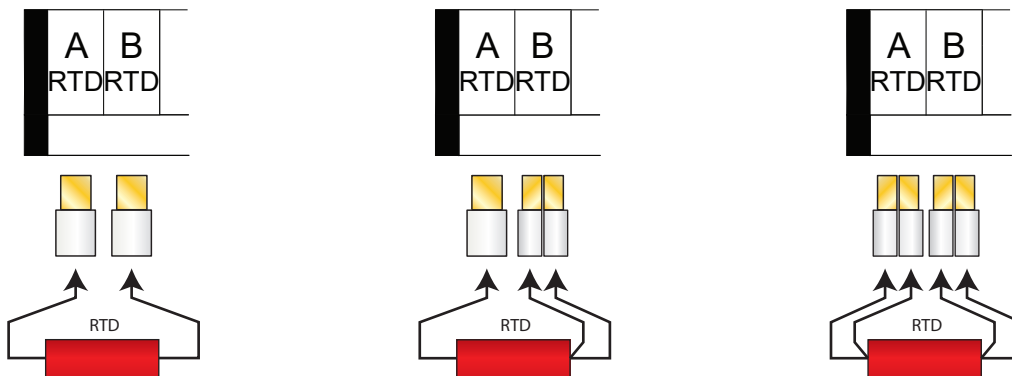

Fig. 18 - Temperature sensor wiring diagram. Two (left), three (middle) and four (right) wire technology.

4.3.6. Connecting the analog output

The ADCATrol BCS220 features a analog output wich can terminate into a load resistance not exceeding 750 ohm and is galvanically isolated from the rest of the instrument. For best noise immunity use a screened twisted pair cable, with the screen connected to Earth at one end. Use a sufficiently large cable to avoid a high resistance in the overall current loop.

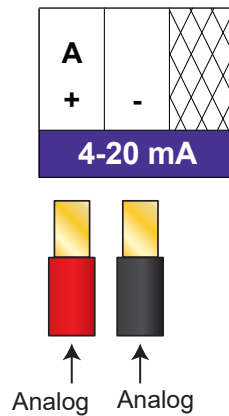

Fig. 19 - Current output wiring diagram.

4.3.7. Connecting the digital input

The ADCATrol BCS220 features a single digital input, which can be used to initiate a user configurable instrument operation by use of a volt free link, switch or relay. The instrument can be configured to initiate the appropriate action when the contact either closes or opens.

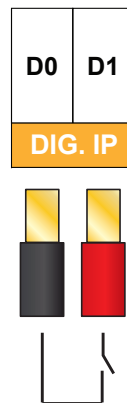

Fig. 20 - Digital input wiring diagram.

4.4. Using the MicroSD card interface

The ADCATrol BCS220 features a MicroSD card interface which is compatible with SD, SDHC and SDXC formatted cards (SDXC cards may need formatted to Fat32 before use). Its primary function is to enable the upgrading of the instruments operating software.

To insert the card, ensure that the side notch is on the right-hand side of the card and push it all the way in to the socket.

To remove the card push it in and release. The card should then come out of the socket.

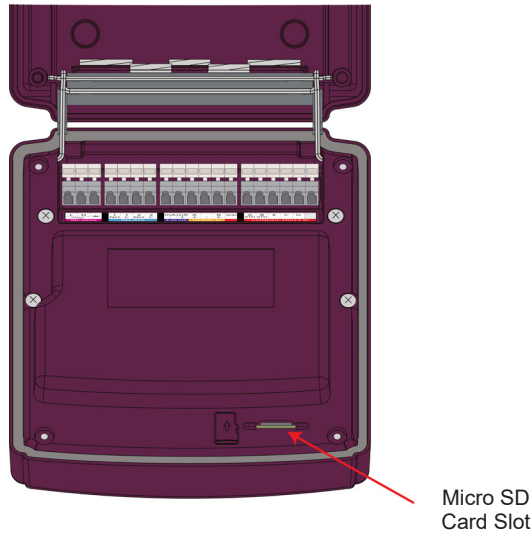

Micro SD Card Slot

Fig. 21 - MicroSD card interface.

5. COMMISSIONING

NOTICE

Before proceeding, ensure that the installation instructions have been followed correctly referring to section 4 – Installation. Failure to do so may result in irreparable damage to the instrument or an electrically hazardous installation.

The ADCATrol BCS220 uses a 3.75” 240 x 128 dot LCD module to display primary readings and temperature, show operational status and to provide an intuitive user interface. This is accompanied by 5 control buttons whose function varies depending upon which screen the user is viewing. The button functions are indicated by the control section at the bottom of the display.

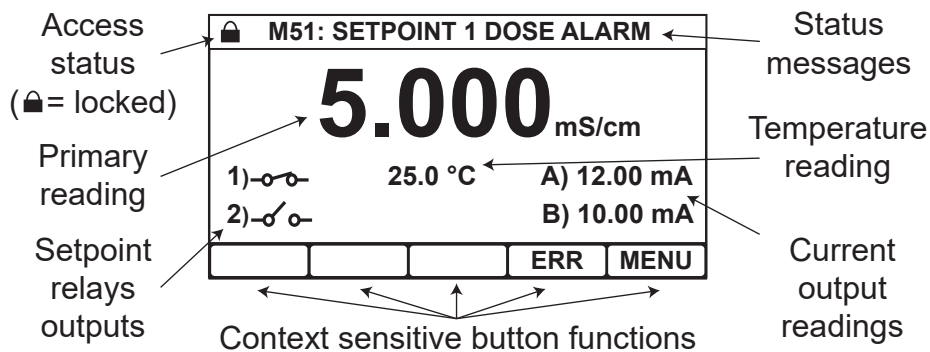

Fig. 22 - Front screen.

Pressing the view button on the front screen cycles through 2 additional front screen options. Note that if an error occurs the instrument will automatically return to the standard front screen shown in Fig. 19.

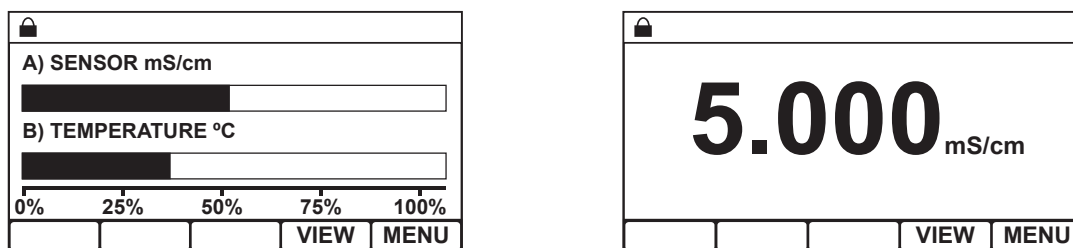

Fig. 23 - Additional front screens. Current output bar graph (on the left) and main reading only screen (on the right).

The main menu is split into two main sections.

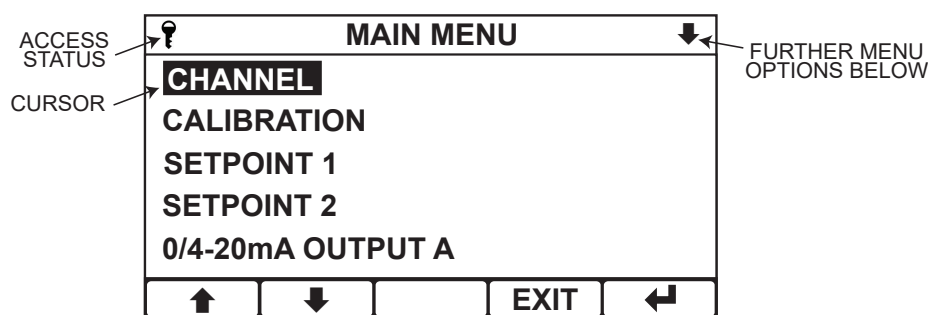

Fig. 24 - Main menu screen.

The upper section shows the current menu the user is in, the access status of the instrument and whether there are further menu options below. The lower section shows the current options for that menu which may be selected by moving the cursor with the up and down arrow buttons and pressing the enter button. The exit button is used to return to the previous menu. If no buttons are pressed after 2 minutes the instrument will default back to the front screen.

5.1. Security access code

To protect the instrument setup from unauthorised or accidental tampering, a security access code system is present. This is implemented via the instrument's menu system which operates in two modes, "locked" as indicated by a padlock symbol and "unlocked" as indicated by a key symbol. The locked mode, or "view only" mode, allows the user to observe the instruments configuration without the ability to change it. If the user wishes to change a setting then the "Security Code" menu will appear, requesting a security access code which will then change the instruments mode to "unlocked". Once unlocked, the user can change any setting without having to re-enter the security access code. The instrument will automatically lock itself if no further buttons are pressed after 2 minutes and 30 seconds.

i NOTE

The user can select his own security access code in the set access code function of the configuration menu, or alternatively completely disable the security system by changing the access code to 0000.

The default security access code is **1000**.

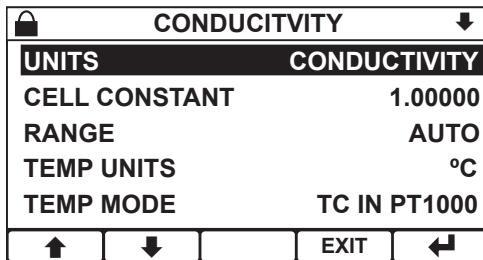

Select the option you wish to change and press enter to bring up the Security Access Code menu.

- ↑ / ↓ – Select option
- EXIT – Cancel
- ← – Chose option

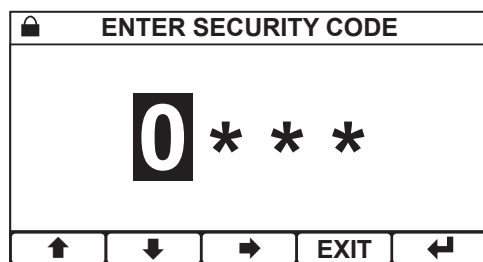

Enter the required Access Code.

If the code is incorrect the user will be prompted to try again.

If the code is correct the padlock at the top of the screen will turn to a key and the unit will be unlocked.

- ↑ / ↓ – Increase/decrease digit
- – Select next digit
- EXIT – Cancel
- ← – Enter code

5.2. Conductivity input setup

The Channel menu contains all the basic configurations for the conductivity probe input.

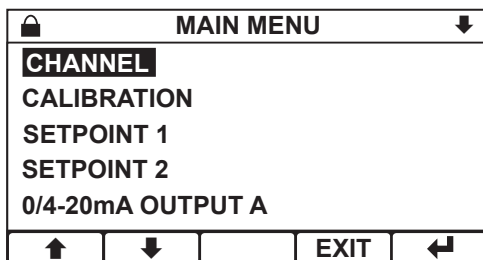

Main menu

From the front screen press the menu button to show the main menu options.

- ↑ / ↓ – Select option
- EXIT – Return to front screen
- ← – Enter option

CONDUCIVITY	
UNITS	CONDUCIVITY
CELL CONSTANT	1.00000
RANGE	AUTO
TEMP UNITS	°C
TEMP MODE	TC IN PT1000
↑	↓
EXIT	↵

Channel menu

From the main menu highlight "Channel" and press the enter button to show the menu options.

- ↑ / ↓ – Select option
- EXIT – Return to main menu
- ↵ – Enter option

UNITS	
CONDUCIVITY	
RESISTIVITY	
TDS(ppm)	
↑	↓
EXIT	↵

Units

The unit can be setup to display conductivity in Siemens/cm, resistivity in Ohms/cm or TDS (Total Dissolved Solids) in ppm.

- ↑ / ↓ – Select option
- EXIT – Cancel
- ↵ – Save selection

CELL CONSTANT	
01.00000	
↑	↓
→	↵
EXIT	↵

Cell constant

Enter the conductivity probe cell constant in case it is known. If unknown set to 1.

- ↑ / ↓ – Select option
- EXIT – Cancel
- ↵ – Save value

RANGE	
AUTO	
99.99µS/cm	
999.9µS/cm	
9999µS/cm	
9.999mS/cm	
↑	↓
EXIT	↵

Range

Select the desired operating range for the input or select auto to let the instrument select the appropriate operating range. Available options depend upon the cell constant selected. See Table 1 for further details.

- ↑ / ↓ – Select option
- EXIT – Cancel
- ↵ – Save selection

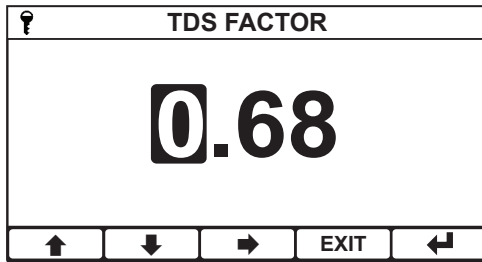

TDS factor

When TDS is selected as the operating unit the instrument will display the conductivity in parts per million (ppm) using a factor which can be adjusted between 0.5 and 0.9.

- ↑ / ↓ – Increase/decrease digit
- – Select next digit
- EXIT – Cancel
- ← – Save value

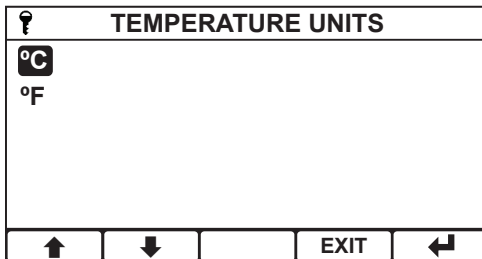

Temperature units

Sets the temperature units used.

- ↑ / ↓ – Select option
- EXIT – Cancel
- ← – Save selection

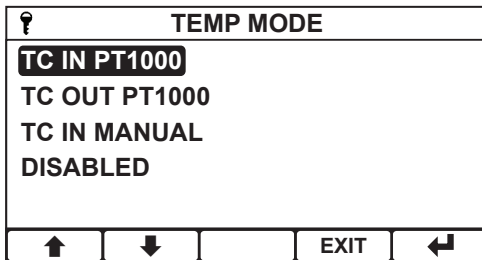

Temperature mode

Temperature compensation is enabled by setting the temperature mode to either "TC IN PT1000", "TC IN PT100" or "TC IN Manual".

When measuring boiler conductivity with a ADCATrol SPS21 or SPS33 probe and an external temperature sensor is not connected, make sure the temperature mode is set to "TC IN Manual".

The boiler operating temperature should then be entered in the manual temperature input function.



Always use a temperature sensor and perform automatic temperature compensation in the following cases:

- If the boiler is working with varying pressures.
- For condensate monitoring and contamination detection applications.
- Feedwater tank conductivity monitoring and control applications.
- For coil water tube boilers, where temperature may vary.

"TC OUT PT1000" and "TC OUT PT100" sets the TC to out whilst still allowing the instrument to measure the temperature input allowing it to be used for the setpoints and analog output.

- ↑ / ↓ – Select option
- EXIT – Cancel
- ← – Save selection

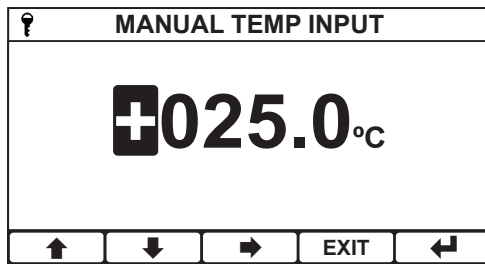

Manual temperature input

Sets the fixed temperature value used for manual temperature compensation. This function is only available if temperature mode is set to "TC IN Manual".

Example: In case of a ADCATrol SPS33 probe directly connected to the shell of a boiler producing steam at 10 barg, the manual temperature input should be set to 184,1 °C.

- Increase/decrease digit
- Select next digit
- EXIT – Cancel
- Save value

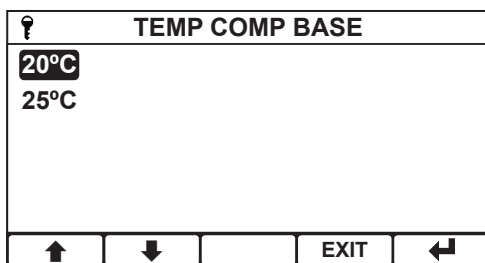

Temperature compensation base

Sets the temperature compensation base.

This function is only available if temperature mode is set to "TC IN Manual".

- Select option
- EXIT – Cancel
- Save selection

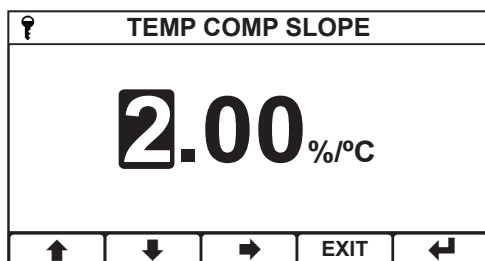

Temperature compensation slope

Sets the temperature compensation slope (may be required for liquids other than water). The ADCATrol BCS220 can be used to determine the temperature coefficient - temperature compensation slope - of the solution being monitored in case it is unknown. Consult Valsteam ADCA.

This function is only available if temperature mode is set to "TC IN PT1000", "TC IN PT100" or "TC IN Manual".

- Increase/decrease digit
- Select next digit
- EXIT – Cancel
- Save value

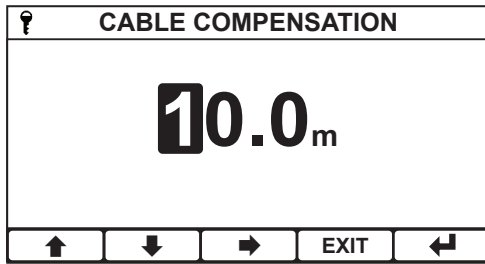

Cable length compensation

At high conductivities the series resistance in the cable connecting the probe to the controller can have a significant effect on the conductivity measurement. By entering the cable length here, the instrument can estimate the extra series resistance and subtract it from the displayed conductivity measurement. This will greatly reduce the error, however to achieve even greater accuracy proceed as follows:

1. Attach a 10Ω resistor to the cable at the sensor end and set the cable length to zero.
2. Observe the instrument reading (in mS/cm).
3. Use the reading to determine the cable length using the following formula: Cable Length= $\{[(1/\text{Reading})-10]/0.0725\}$.

- ↑ / ↓ – Increase/decrease digit
- ➡ – Select next digit
- EXIT – Cancel
- ← – Save value

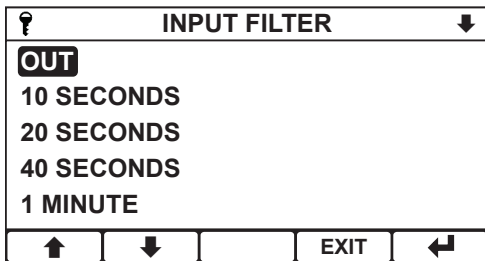

Input filter

In noisy environments, this function will allow the user to filter the sensor readings by taking a running average over the selected time period.

- ↑ / ↓ – Increase/decrease digit
- EXIT – Cancel
- ← – Save selection

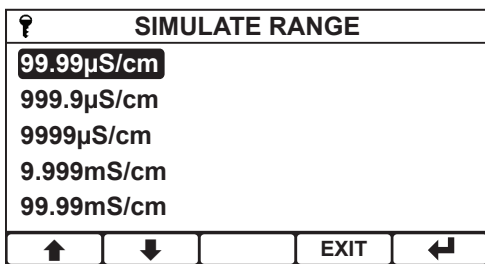

Simulated range

Set the range over which the simulate sensor mode will operate.

- ↑ / ↓ – Select option
- EXIT – Return to main menu
- ← – Enter option

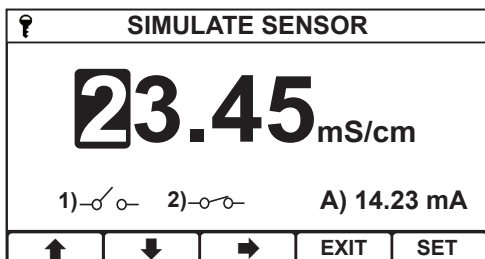

Simulate sensor

A useful feature during commissioning and troubleshooting. Allows simulation of the conductivity reading to test e.g. engagement of relay outputs, setpoint settings as well as the analog output.

- ↑ / ↓ – Increase/decrease digit
- ➡ – Select next digit
- EXIT – Cancel
- ← – Use entered value

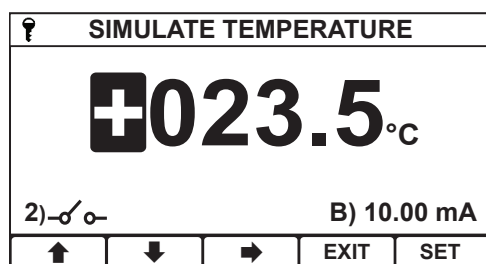

Simulate temperature

A usefull feature during comissioning and troubleshooting. Allows simulation of the temperature reading to test e.g. engagement of relay outputs, setpoint settings as well as the analog output.

- ↑ / ↓ – Increase/decrease digit
- – Select next digit
- EXIT – Cancel
- ← – Use entered value

5.3. Calibration

The ADCATrol BCS220 provides a means for the operator to fine tune the calibration of conductivity and temperature measurements as well as the analog output. If it is found that during a calibration there is insufficient adjustment then it is likely that there is a problem with either the calibration procedure, improper installation of the probe or a fault with the controller, sensor or cabling. The most common causes of inaccurate conductivity readings are contaminated electrode surfaces and improper probe installation wich leads to steam or air trapped in the sensor chamber. Both of these will always give a low conductivity (high resistivity) reading.

Conductivity measurement is temperature dependent and thus it is essential to understand the complex relationship between conductivity and temperature when performing calibrations. Several types of calibration can be performed with the ADCATrol BCS220, among which:

Calibration by comparison with another instrument

By far the easier method for in-situ calibrations. Measurements are made by comparison of the readings taken by the installed system and e.g. a portable conductivity meter. Since measurements are made by comparison of the readings taken in the same solution, temperature effects are less critical.

In a steam boiler application, the procedure is as follows:

A sample of cooled boiler water is taken and measured by the portable instrument. The ADCATrol BCS220 is then calibrated to match the measured value – see “Sensor solution calibration” menu entry. Since the boiler water is at a much higher temperature than the sample it is imperative that both instruments have the same temperature compensation base.

Calibration through setting of cell constant

Many conductivity probes are supplied with a nominal cell constant value. If that is the case the user may program the exact value into the instrument. Conductivity probes such as the SPS21 and SPS33 however are very much influenced by the conducting metallic parts surrounding the probe such as chambers, tubes and

others. In these scenarios calibration by means of cell constant can only be performed by trial and error and is thus not recommended. Consult Valsteam ADCA.

Calibration with a standard solution

This calibration must be carried out in a controlled environment due to the temperature effect on the conductivity measurement and possibility of contamination of the standard solution. This method is not recommended for calibrating solutions below 500 $\mu\text{S}/\text{cm}$ and is also seldomly used in steam boiler applications.

The standard solution is supplied with a conductivity value quoted at a reference temperature. This temperature is the base temperature and the calibration should be performed at that temperature, with the temperature compensation switched off.

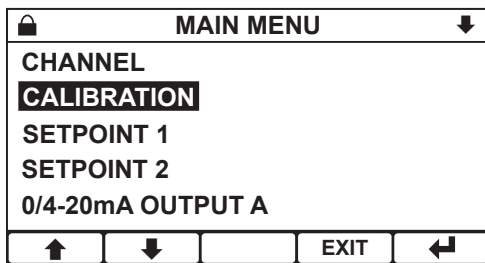

Main menu

From the front screen press the menu button to show the main menu options.

- Select option
- EXIT – Return to front screen
- Enter option

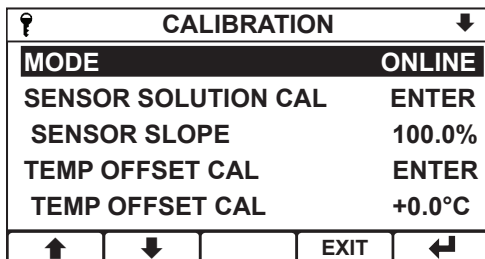

Calibration menu

From the main menu highlight “Calibration” and press enter to show the menu options.

- Select option
- EXIT – Return to main menu
- Enter option

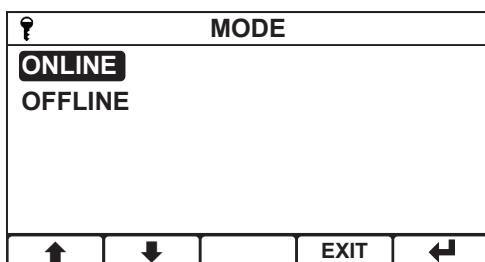

Mode

Selecting “Offline” causes any setpoints to de-energise and analog output to go to its offline state. Useful, when commissioning or calibrating the instrument.

When the instrument is placed in an offline state “Offline” will appear on the front screen.

- Select option
- EXIT – Cancel
- Save selection

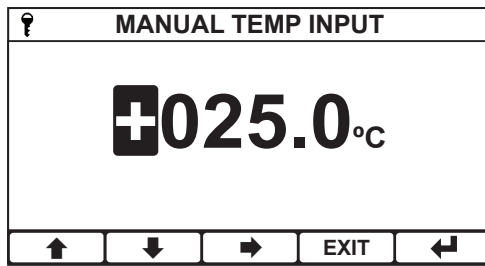

Calibration manual temperature input

Allows a different fixed temperature value to be used when calibrating. Makes it easier to calibrate a standard solution at a different temperature to the process. Only Available if "Temperature mode" is set to "TC IN Manual" in the "Channel" menu.

- ↑ / ↓ – Increase / Decrease Digit
- EXIT – Select next digit
- ← – Save value

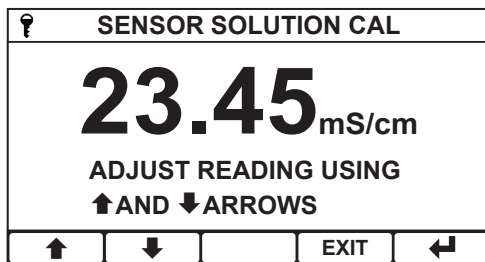

Sensor solution calibration

Enables the user to adjust the sensor reading to match a known input measured value from another instrument or from a standard solution.

The current sensor reading can be seen in the pop-up window and is adjusted by pressing the up and down arrows. When the reading is correct press the enter button to store the calibration. The calculated slope or offset, depending on the instruments units, are shown in the next menu entry.

- ↑ / ↓ – Adjust the reading up or down
- EXIT – Select next digit
- ← – Save calibration

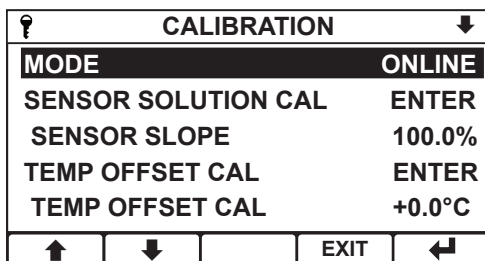

Sensor slope

The sensor slope value currently being used. Cannot be edited.

The value will change depending on the result of the sensor solution calibration.

A slope value of 100% indicates that no adjustment has been made to the sensor calibration.

A slope value greater than 100% indicates that the sensor reading had to be increased to match the known input.

A slope value of less than 100% indicates that the sensor reading had to be decreased to match the known input.

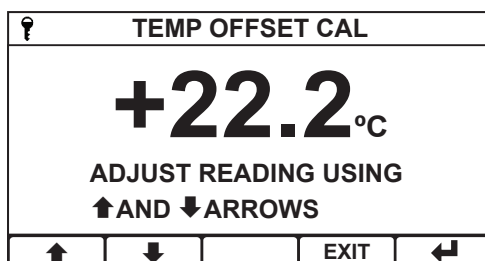

Temperature offset calibration

Enables the user to adjust the temperature reading to match a known input measured from another instrument.

The current temperature reading can be seen in the pop-up window and is adjusted by pressing the up and down arrows. When the reading is correct press the enter button to store the calibration. The calculated offset is shown in the next menu entry.

- ↑ / ↓ – Adjust the reading up or down

CALIBRATION	
MODE	ONLINE
SENSOR SOLUTION CAL	ENTER
SENSOR SLOPE	100.0%
TEMP OFFSET CAL	ENTER
TEMP OFFSET CAL	+0.0°C
↑	↓
	EXIT
	↵

Temperature offset value

The temperature offset value currently being used. Cannot be edited.

The value will change depending on the result of the temperature offset calibration.

FRONT CAL ACCESS	
YES	
NO	
↑	↓
	EXIT
	↵

Front screen calibration access

When enabled allows direct entry into the calibration menu from the front screen by pressing the CAL button.



Enabling access to calibration in the front screen will disable the security access system within the calibration, allowing calibration without having to enter the security access code.

- ↑ / ↓ – Select option
- EXIT – Cancel
- ↵ – Save selection

CALIBRATION	
FRONT CAL ACCESS	NO
RESET SENSOR	RESET
RESET TEMPERATURE	RESET
↑	↓
	EXIT
	↵

Reset sensor

Reset any user sensor calibration that may have been performed.

- ↑ / ↓ – Select option
- EXIT – Return to main menu
- ↵ – Enter option

CALIBRATION	
FRONT CAL ACCESS	NO
RESET SENSOR	RESET
RESET TEMPERATURE	RESET
↑	↓
	EXIT
	↵

Reset temperature

Reset any user temperature calibration that may have been performed.

- ↑ / ↓ – Select option
- EXIT – Return to main menu
- ↵ – Enter option

5.4. Configuring the setpoint functions

The ADCATrol BCS220 is supplied with 2 normally-open volt free relay outputs designated with numbers 1 and 2. The instrument indicates the status of the relay by means of a symbol on the front screen.



Indicates that the relay contact is open.



Indicates that the relay contact is closed (if flashing indicates that a dose alarm has occurred).

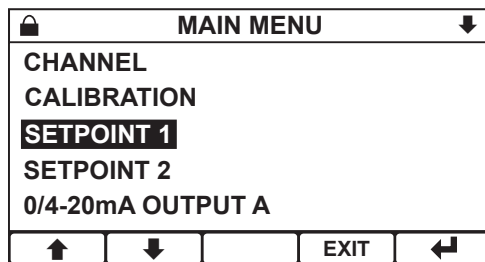

Main menu

From the front screen press the menu button to show the main menu options and select the setpoint to be configured. "Setpoint 1" and "Setpoint 2" are associated with relay output 1 and 2 respectively.

↑ / ↓ – Select option

EXIT – Return to front screen

← – Enter option

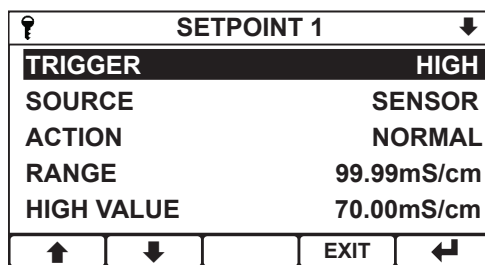

Setpoint menu

Select the setpoint function to be configured.

↑ / ↓ – Select option

EXIT – Return to main menu

← – Enter option

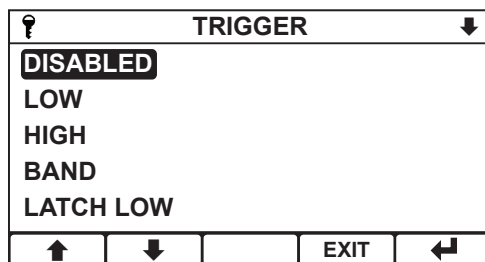

Trigger

The setpoints can be configured to trigger in the following ways:

- Low/High
- Band
- Latch low/Latch high
- Blowdown high/Blowdown low (Available in "Setpoint 1" only)
- Blowdown Timer (Available in "Setpoint 2" only)
- USP (Available in "Setpoint 1" Only)
- USP Pre-Trigger (Available in "Setpoint 2" only)

When the setpoint is active, the respective relay coil energizes and relay contact closes.

↑ / ↓ – Select option

EXIT – Cancel

← – Save selection

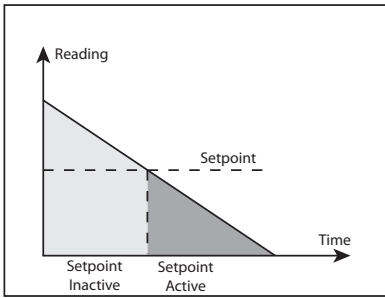

Low

Active when the sensor reading decreases below the setpoint.

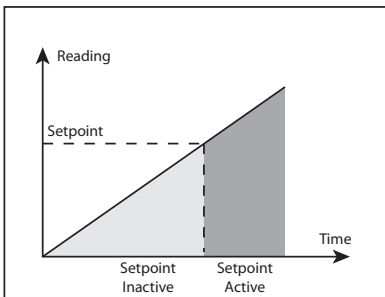

High

Active when the sensor reading increases above the setpoint.

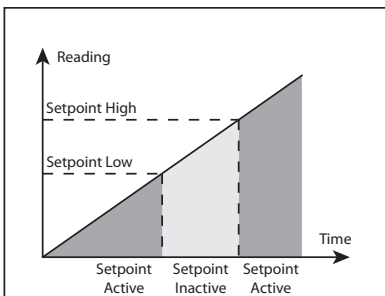

Band

Active when the sensor reading is either greater than the setpoint High level or less than the setpoint Low level.

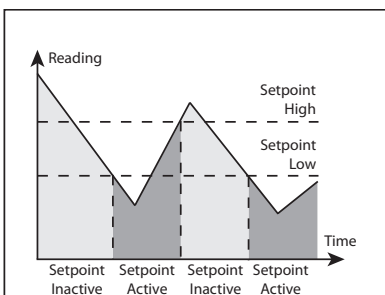

Latch Low

Active when the sensor reading is less than the setpoint low level and will remain active until the reading rises above the setpoint High level. It will then remain inactive until the reading level falls below the setpoint Low level.

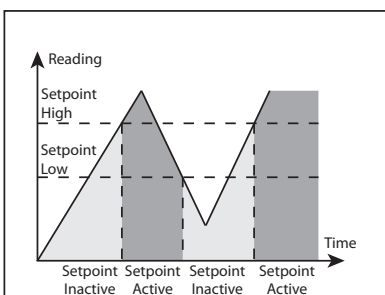

Latch High

Active when the sensor reading is greater than the setpoint high level and will remain active until the reading falls below the setpoint Low level. It will then remain inactive until the reading rises above the setpoint High level.

?					SOURCE				
SENSOR ERROR									
DOSE ALARM									
CALIBRATION									
OFFLINE									
ANY ERROR									
↑		↓				EXIT		↵	

Alarm

Active when:

- A sensor related error is detected – Sensor Error.
- The dose alarm activates – Dose Alarm.
- Calibration is in progress – Calibration.
- The instrument is taken offline – Offline.
- Any error is detected.

↑ / ↓ – Select option

EXIT – Cancel

↵ – Save selection

?					SAMPLE TIME				
00.15 mm:ss									
↑		↓		→		EXIT		↵	

Blowdown high/Blowdown low (Setpoint 1 only)

Useful for when the conductivity probe is mounted directly in the blowdown line of a steam boiler, in series with the TDS blowdown valve. This mode ensures the sensor measures conductivity at boiler temperature.

The “Sample time” is the period of time the relay is activated to open the TDS blowdown valve and enabling a representative sample of boiler water to reach the probe at saturated temperature.

At the end of the “Sample time” the sensor reading is compared to the setpoint and if higher or lower (depending on the selected trigger) than the setpoint the relay will stay active until the setpoint condition is satisfied – see “Blowdown mode” menu entry.

Once the setpoint condition is satisfied the relay will turn off for a user selected time period called “Cycle time”. At the end of the “Cycle time” the blowdown relay will once again go into the “Sample time” and the process repeats.

↑ / ↓ – Increase/decrease digit

→ – Select next digit

EXIT – Cancel

↵ – Save value

?					CYCLE TIME				
30.00 mm:ss									
↑		↓		→		EXIT		↵	

? BLOWDOWN MODE				
NORMAL				
PULSED				
↑	↓		EXIT	↵

? ON TIME				
00.20 mm:ss				
↑	↓	→	EXIT	↵

? OFF TIME				
00.40 mm:ss				
↑	↓	→	EXIT	↵

Blowdown mode (Setpoint 1 only)

This function is only available if the setpoint trigger is set to "Blowdown high" or "Blowdown low".

When the "Sample time" has ended the sensor reading is compared to the setpoint and, if not satisfied, the relay will stay active until the setpoint condition is satisfied, in one of two modes:

- Normal: Indefinitely and continuously active until the setpoint condition is satisfied.
- Pulsed: Active during a period of time called "On time" and inactive during a period of time called "Off time", repeating in cycles (pulses) until the setpoint condition is finally satisfied.



The pulsed blowdown mode is particularly recommended for small boilers, where the capacity of the TDS blowdown valve is relatively high compared to the boiler size.

The pulsed output slows the rate at which the boiler water is discharged so as to minimize the possibility of triggering a low water level.

- ↑ / ↓ – Increase/decrease digit
- – Select next digit
- EXIT – Cancel
- ↵ – Save value

? ON TIME				
00.20 mm:ss				
↑	↓	→	EXIT	↵

? OFF TIME				
00.40 mm:ss				
↑	↓	→	EXIT	↵

Blowdown timer (Setpoint 2 only)

Complementary to the blowdown high/low operation of setpoint 1. Allows configuration of the interval – "Off time" – and duration – "On time" – of a intermittent blowdown valve cycle.

Current blowdown time is visible on the front measurement screen. When energised the text "TIMER B-DOWN" is shown.

- ↑ / ↓ – Increase/decrease digit
- – Select next digit
- EXIT – Cancel
- ↵ – Save value

TIMER DELAY				
<p>YES</p> <p>NO</p>				
↑	↓		EXIT	↩

Blowdown timer delay (Setpoint 2 only)

If enabled will prevent the blowdown timer from energising until setpoint 1 is de-energised.

When setpoint 2 is being held from energising "TIMER DELAYED" will appear on the front measurement screen.

Whilst the setpoint is being delayed the user has an option to acknowledge the delay and move setpoint 2 to the de-energized phase, skipping any timer blowdown until the de-energised phase has once again been completed. This is accomplished by using the ACK button whilst on the front measurement screen.

↑ / ↓ – Increase/decrease digit

EXIT – Cancel

↩ – Save value

SETPOINT 1	
TRIGGER	USP
ACTION	NORMAL
↑	↓
	EXIT
	↩

USP (Setpoint 1 only)

The USP (United States Pharmacopeia) is used by most pharmaceutical companies as a standard set of procedures to ensure that they will comply with FDA requirements. This is applied to conductivity measurements (Chapter 645), which is used to determine if the water, e.g. water for injection (WFI), meets strict quality standards.

According to Chapter 645, conductivity is used as the first test (Stage 1) and can be an online measurement. The measurement is used to determine the maximum level of dissolved minerals that are in the solution, which it is ideally suited to do. However, the conductivity of a solution varies with temperature as well as the contaminants in it, and this temperature dependence varies with the type of contaminant. In order to compensate for this most conductivity instruments apply a temperature compensation factor, usually 2%/°C, but due to the wide variation in the quality of different manufacturers temperature compensation systems USP has specified that all measurements must be made uncompensated. The adjacent table lists the maximum allowed conductivity values at a series of different temperatures.

Setting the trigger to "USP" causes the setpoint to operate to the USP levels. Other than "Action", all other setpoint parameters will be unavailable.

Temp. (° C)	Cond. (µS/cm)	Temp. (° C)	Cond. (µS/cm)
0	0,6	55	2,1
5	0,8	60	2,2
10	0,9	65	2,4
15	1	70	2,5
20	1,1	75	2,7
25	1,3	80	2,7
30	1,4	85	2,7
35	1,5	90	2,7
40	1,7	95	2,9
45	1,8	100	3,1
50	1,9		



USP is only available if the following parameters are set in the "Channel" menu:

"Units" set to "Conductivity"; "Cell constant" is less than 0.05; "Range" is set to "0 to 9,999 µS/cm"; and "Temperature mode" is set either "TC OUT PT1000" or "TC OUT PT100".

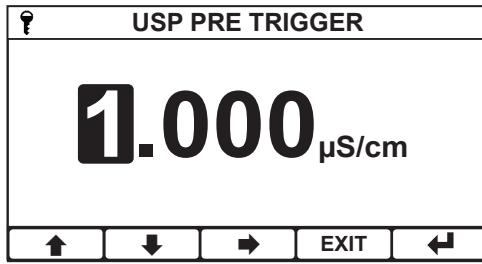

USP Pre-Trigger (Setpoint 2 only)

When setpoint 1 is set to "USP", setpoint 2 can be set as a pre-trigger and will cause the setpoint to activate by the pre-trigger amount, in $\mu\text{S/cm}$, before the USP level.

Example: If the USP setpoint 1 was due to activate at 1300 $\mu\text{S/cm}$ and the pre-trigger in setpoint 2 was set to 0,2 $\mu\text{S/cm}$ then setpoint 2 would trigger at 1,1 $\mu\text{S/cm}$.

- Increase/decrease digit
- Select next digit
- EXIT – Cancel
- Save value

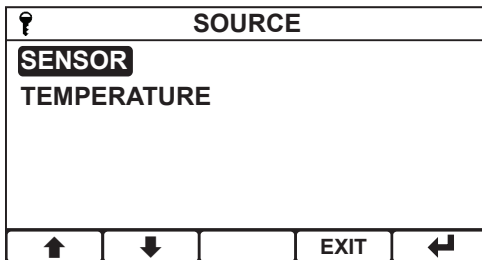

Source

Select the source for the setpoint.



"Temperature" option is only available if the "Temperature mode" setting in the "Channel" menu is not set to "TC IN PT1000", "TC IN PT100", "TC OUT PT1000" or TC OUT PT100".

- Select option
- EXIT – Cancel
- Save selection

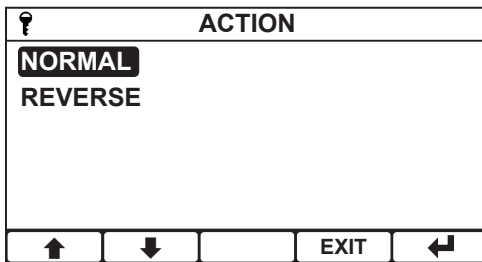

Action

Sets the software action of the relay.

In "Normal" mode the relay will operate as normally-open. In "Reverse" mode the relay will operate as normally-closed with the exception that in case of power failure it will still fall open.

- Select option
- EXIT – Cancel
- Save selection

RANGE				
99.99µS/cm				
999.9µS/cm				
9999µS/cm				
9.999mS/cm				
99.99mS/cm				
↑	↓		EXIT	↵

Range

Sets the setpoint operating range.

This function is only available if the “Sensor range” in the “Channel” menu has been set to “Auto”. Otherwise the setpoint will operate over the selected range under the “Channel” menu.

- ↑ / ↓ – Select option
- EXIT – Cancel
- ↵ – Save selection

LOW VALUE				
10.00 mS/cm				
↑	↓	→	EXIT	↵

Low Value

Sets the setpoint Low value.

- ↑ / ↓ – Increase/decrease digit
- – Select next digit
- EXIT – Cancel
- ↵ – Save value

HIGH VALUE				
70.00 mS/cm				
↑	↓	→	EXIT	↵

High Value

Sets the setpoint High value.

- ↑ / ↓ – Increase/decrease digit
- – Select next digit
- EXIT – Cancel
- ↵ – Save value

MODE				
ON-OFF				
PULSE PROPORTIONAL				
TIME PROPORTIONAL				
↑	↓		EXIT	↵

Mode

The setpoints can operate in one of the following modes:

- On/Off – When the setpoint is active, the respective relay coil energizes and relay contact closes.
- Pulse Proportional – see section 5.4.1 - Setpoint proportional mode.
- Time Proportional – see section 5.4.1 - Setpoint proportional mode.

This function is only available if “Trigger” is set to either “High” or “Low”.

- ↑ / ↓ – Select option
- EXIT – Cancel
- ↵ – Save selection

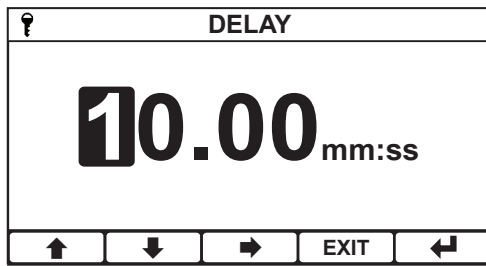

Delay

In order to prevent short duration changes at the input affecting the setpoint operation, a delay can be set before the relay coil is energised. If the input is still the same after the delay, then the relay coil will be energised.

This function is only available if "Trigger" is set to either "High", "Low", "Band" and "Mode" is set to "On/Off".

- ↑ / ↓ – Increase/decrease digit
- – Select next digit
- EXIT – Cancel
- ← – Save value

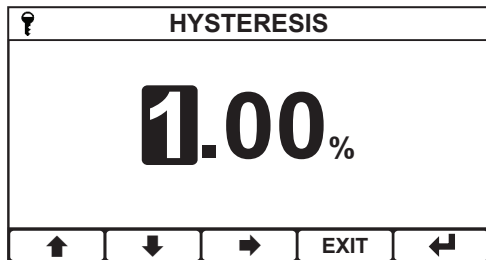

Hysteresis

A facility to apply hysteresis to the setpoint level allows the user to avoid setpoint "chatter" when the reading level approaches the setpoint level. "Chatter" occurs when the reading is sufficiently close to the setpoint value and noise on the signal repeatedly crosses the setpoint level, thus causing the relay to switch on and off rapidly.

The hysteresis level should therefore be set to be greater than the input noise level. Its value is a percentage of the setpoint value applied both + and - to the setpoint.

Example: If the setpoint is 10 and the Hysteresis is 1% then the hysteresis band will operate from 9,9 to 10,1.

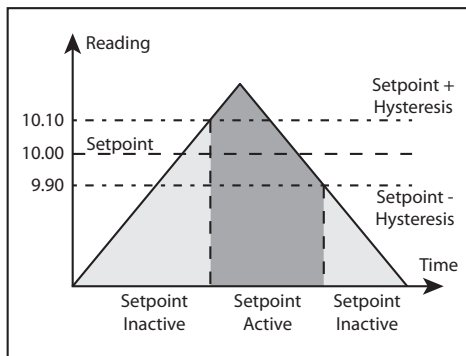

Hysteresis operates as follows:

- Trigger High – The setpoint is inactive until the reading is greater than the setpoint High + (setpoint High x hysteresis %). It remains active until it goes below Setpoint High – (setpoint High x hysteresis %).
- Trigger Low – The setpoint is inactive until the reading is less than the setpoint Low – (setpoint Low x hysteresis %). It remains active until it goes above setpoint Low + (setpoint Low x hysteresis %).
- Trigger Band – The setpoint will activate in both Trigger High and Trigger Low scenarios.

This function is only available if "Trigger" is set to either "High", "Low", "Band" and "Mode" is set to "On/Off".

- ↑ / ↓ – Increase/decrease digit
- – Select next digit
- EXIT – Cancel
- ← – Save value

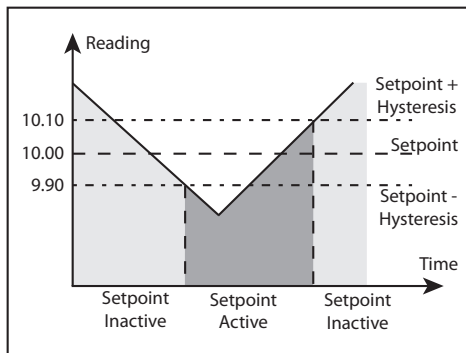

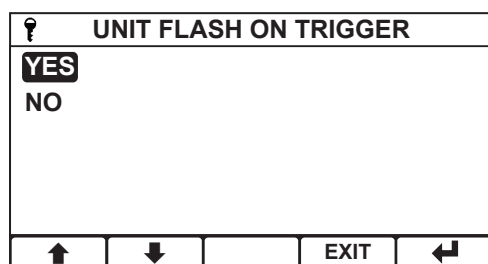

Unit flash on trigger

When enabled the backlight of the LCD screen will flash when the setpoint has been triggered.

- ↑ / ↓ – Select Option
- EXIT – Cancel
- ← – Save Selection

5.4.1. Setpoint proportional mode

In addition to the “On/Off” mode the controller also provides two forms of pseudo proportional control, which can be used to control the levels to a defined value when used in conjunction with a valve or pump. When the reading deviates from the programmed setpoint level the relay pulses at a rate proportional to that deviation.

This function is only available if “Trigger” is set to either “High” or “Low”.

Pulse proportional mode

Intended to drive valve actuators which can be controlled via an external pulse input signal. The setpoint operates by producing a pulse of 0,25 seconds in duration with a maximum period of one pulse per 30 seconds. The pulse rate increases as the measurement moves away from the setpoint, until it reaches the minimum period of one pulse per 0,5 seconds at the limit of the proportional band.

For example if the proportional band is set to “1”, the setpoint trigger to “Low”, and a setpoint value of “10”. When the reading falls just below “10” the relay will begin to pulse at its longest period of once every 30 seconds. As the reading falls further from the setpoint the period will decrease until it reaches its minimum of one pulse every 0,5 seconds at the limit of the proportional band. See Fig. 22.

Time proportional mode

Time Proportional Mode allows a user defined cycle time to control any on/off device such as a solenoid valve over a set proportional band.

For example if the user sets a proportional band of “1”, the setpoint “Trigger” to “Low” and a setpoint value of “10”. When the reading falls below “9” the relay will be energised 100% of the cycle time. As the input rises and approaches the setpoint the relay starts to cycle on and off with the on time reducing and the off time increasing, respectively until it reached the setpoint and would be off for 100% of the cycle time. The cycle time is adjustable and is the sum of the on and off times. See Fig. 22.

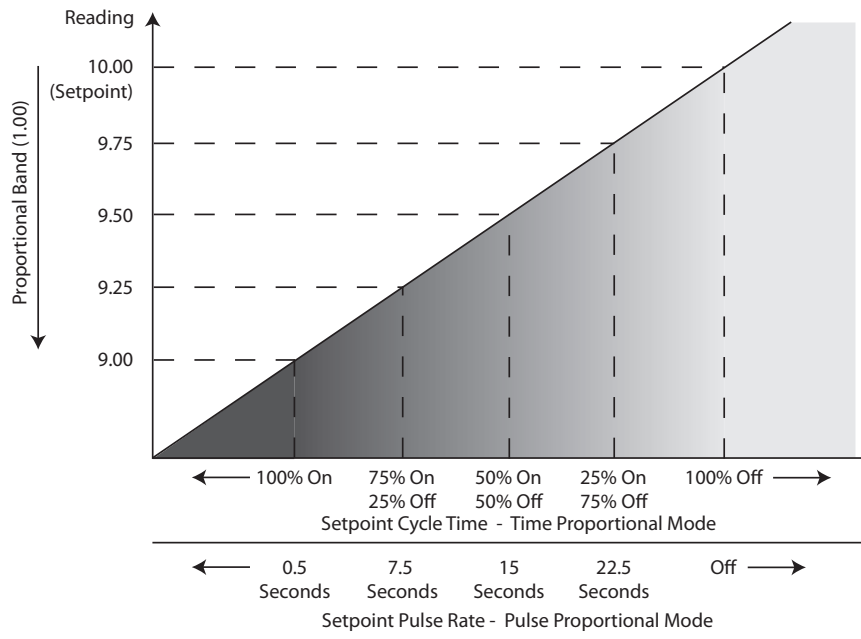

Fig. 25 - Setpoint proportional modes.



Cycle time

Sets the cycle time.

This function is only available if "Mode" is set to "Time proportional".

- ↑ / ↓ – Increase/decrease digit
- – Select next digit
- EXIT – Cancel
- ← – Save value

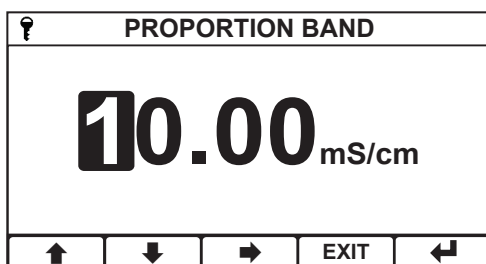

Proportion band

Enter the amount of proportion band.

This function is only available if "Mode" is set to "Time proportional".

- ↑ / ↓ – Increase/decrease digit
- – Select next digit
- EXIT – Cancel
- ← – Save value

5.5. Configuring the 0(4) to 20 mA analog output functions

The ADCATrol BCS220 is supplied with a single 0(4) to 20 mA analog output. The instrument displays the status of the analog output on the front screen, where --- mA indicates that the analog output is disabled.

MAIN MENU				
CHANNEL				
CALIBRATION				
SETPOINT 1				
SETPOINT 2				
0/4-20mA OUTPUT A				
↑	↓		EXIT	↵

Main menu

From the front screen press the menu button to show the main menu options and select "0/4-20mA output".

- ↑ / ↓ – Select option
- EXIT – Return to front screen
- ↵ – Enter option

0/4-20mA OUTPUT A				
OUTPUT MODE		4-20mA		
SOURCE	SENSOR			
RANGE	99.99mS/cm			
ZERO (4mA)	40.00mS/cm			
SPAN (20mA)	80.00mS/cm			
↑	↓		EXIT	↵

0(4) to 20 mA output menu

Select the analog output function to be configured.

- ↑ / ↓ – Select option
- EXIT – Return to main menu
- ↵ – Enter Option

OUTPUT MODE				
DISABLED				
0-20mA				
4-20mA				
↑	↓		EXIT	↵

Output mode

Enables the analog output by selecting its output mode, either "0 to 20 mA" or "4 to 20 mA".

- ↑ / ↓ – Select option
- EXIT – Cancel
- ↵ – Save selection

SOURCE				
SENSOR				
TEMPERATURE				
↑	↓		EXIT	↵

Source

Select the source for the analog output.



"Temperature" option is only available if the "Temperature mode" setting in the "Channel" menu is not set to "TC IN PT1000", "TC IN PT100", "TC OUT PT1000" or TC OUT PT100".

- ↑ / ↓ – Select option
- EXIT – Cancel
- ↵ – Save selection

?		RANGE	
99.99μS/cm			
999.9 μ S/cm			
9999 μ S/cm			
9.999mS/cm			
99.99mS/cm			
↑	↓	EXIT	↵

Range

Sets the analog output operating range.

This function is only available if the "Sensor range" in the "Channel" menu has been set to "Auto". Otherwise the setpoint will operate over the selected range under the "Channel" menu.

- ↑ / ↓ – Select option
- EXIT – Cancel
- ↵ – Save selection

?		ZERO (4mA)	
40.00 mS/cm			
↑	↓	→	↵
EXIT			

Zero (0 or 4 mA)

Enter the desired sensor value to be represented by 0 mA or 4 mA (depends on analog output mode). An inverse relationship can be achieved by setting "Zero" with a value greater than "Span".

- ↑ / ↓ – Increase/decrease digit
- – Select next digit
- EXIT – Cancel
- ↵ – Save value

?		SPAN (20mA)	
80.00 mS/cm			
↑	↓	→	↵
EXIT			

Span (20 mA)

Enter the desired sensor value to be represented by 20 mA. An inverse relationship can be achieved by setting "Span" with a value lower than "Zero".

- ↑ / ↓ – Increase/decrease digit
- – Select next digit
- EXIT – Cancel
- ↵ – Save value

?		ON ERROR	
NO ACTION			
DRIVE TO 0mA			
DRIVE TO 4mA			
DRIVE TO 22mA			
HOLD LEVEL			
↑	↓	EXIT	↵

On error

The analog output can be programmed to output 0 mA, 4 mA, 22 mA or Hold its current value when an error is detected in the input source (i.e. sensor fault or temperature fault) to provide remote monitorization in case of error conditions.

- ↑ / ↓ – Select option
- EXIT – Cancel
- ↵ – Save selection

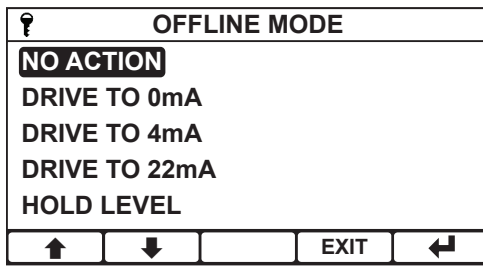

Offline mode

The analog output can be programmed to output 0 mA, 4 mA, 22 mA or Hold its value when the instrument is placed offline.

- ↑ / ↓ – Select option
- EXIT – Cancel
- ← – Save selection

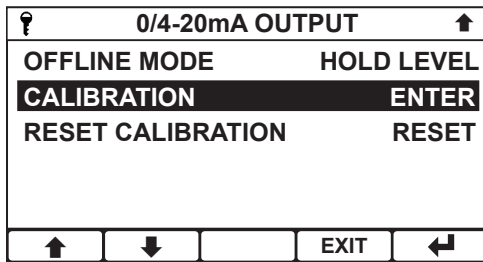

Calibration

Enter to calibrate the analog output.

- ↑ / ↓ – Select option
- EXIT – Return to main menu
- ← – Enter Option

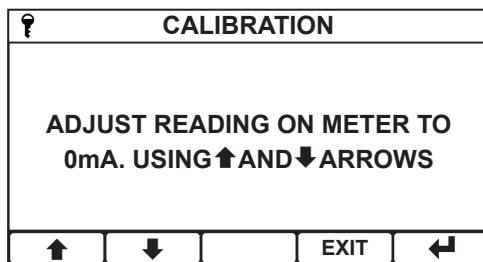

Adjust the zero (0 mA)

Press the up and down arrows to adjust the analog output until it reads the desired value on your calibrated current meter.

Only used when the analog “Output mode” is set to “0 to 20mA”.

- ↑ / ↓ – Adjust output
- EXIT – Cancel
- ← – Save adjustment

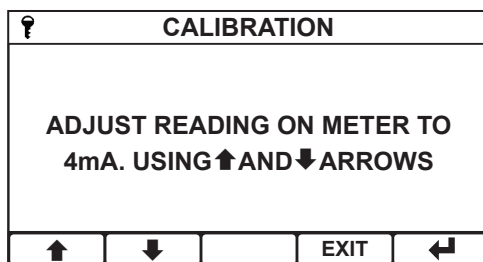

Adjust the zero (4 mA)

Press the up and down arrows to adjust the analog output until it reads the desired value on your calibrated current meter.

Only used when the analog “Output mode” is set to “4 to 20mA”.

- ↑ / ↓ – Adjust output
- EXIT – Cancel
- ← – Save adjustment

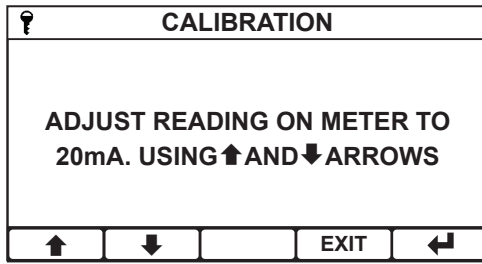

Adjust the span (20 mA)

Press the up and down arrows to adjust the analog output until it reads the desired value on your calibrated current meter.

- ↑ / ↓ – Adjust output
- EXIT – Cancel
- ← – Save adjustment

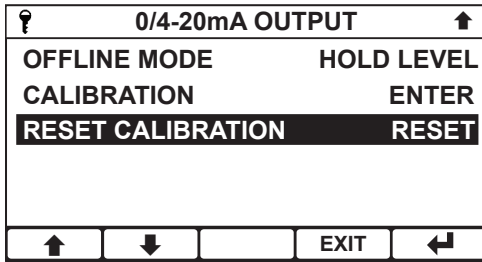

Reset calibration

Used to reset any user calibration applied to the analog output.

- ↑ / ↓ – Select option
- EXIT – Return to calibration
- ← – Enter option

5.6. Configuring the digital input functions

The ADCATrol BCS220 is supplied with a single digital input contact which allows the instrument to be remotely set to either an offline state that forces the relays to deactivate and the analog output to be set to a pre-defined state, or to change the whole configuration of the instrument by switching the setup to a pre-configured state. The setting can be used to de-activate the blowdown system during stand-by operations or when the burner is switched off, avoiding energy waste. The user can select whether closing or opening the contact initiates the configured action.

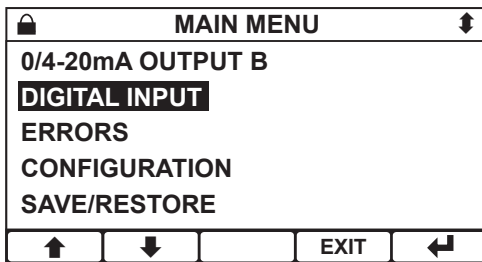

Main menu

From the front screen press the menu button to show the main menu options and select "Digital input".

- ↑ / ↓ – Select option
- EXIT – Return to front screen
- ← – Enter option

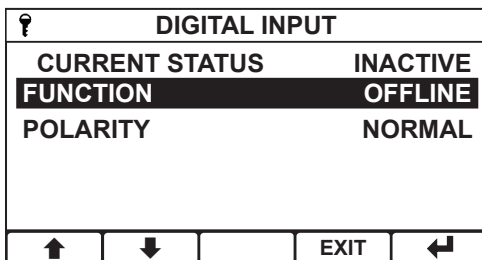

Digital input menu

Select the digital input function to be configured.

- ↑ / ↓ – Select option
- EXIT – Return to main menu
- ← – Enter option

DIGITAL INPUT	
CURRENT STATUS	INACTIVE
FUNCTION	OFFLINE
POLARITY	NORMAL

↑ ↓ EXIT ↩

Current status

Shows the current status of the digital input, for monitorization purposes only.

FUNCTION	
DISABLED	
OFFLINE	
SWITCH SETUP	
INTERLOCK	
FLOW SWITCH	

↑ ↓ EXIT ↩

Function

The digital input can be configured to operate in the following ways:

- Offline, Interlock, Flow switch and Tank level – Once active will put the controller in “Offline” mode. This causes any active setpoints to become inactive, the analog output to change to its “Offline” state and the selected function message to appear on the front screen.
- Switch setup – Once active the instrument will load an alternative sensor, setpoint and analog output setup that has been stored in one of the two internal memory stores. Whilst the digital input is active the instrument configuration cannot be changed. The original configuration is restored once the digital input is inactive once again.

- ↑ / ↓ – Select option
- EXIT – Cancel
- ↩ – Save selection

STORE	
STORE A	
STORE B	

↑ ↓ EXIT ↩

Store

Select which memory store the “Switch setup” will load when active.

- ↑ / ↓ – Select option
- EXIT – Cancel
- ↩ – Save selection

POLARITY	
NORMAL	
REVERSE	

↑ ↓ EXIT ↩

Polarity

Configure whether the digital input activates on the closing of the circuit (“Normal”) or the opening of the circuit (“Reverse”).

- ↑ / ↓ – Select option
- EXIT – Cancel
- ↩ – Save selection

5.7. Configuring the basic operating parameters

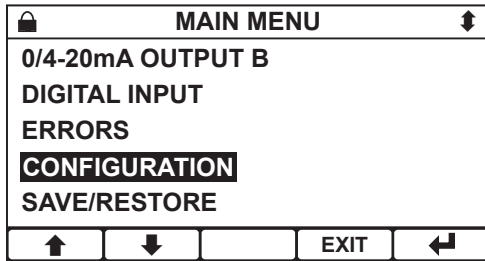

Main menu

From the front screen press the menu button to show the main menu options and select "Configuration".

- ↑ / ↓ – Select option
- EXIT – Return to front screen
- ↵ – Enter option

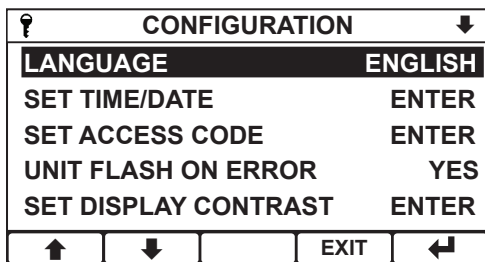

Configuration menu

Select the function to be configured.

- ↑ / ↓ – Select option
- EXIT – Return to main menu
- ↵ – Enter option

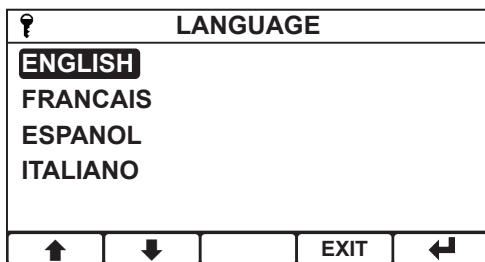

Language

Sets the instrument display language.

- ↑ / ↓ – Select option
- EXIT – Cancel
- ↵ – Save selection

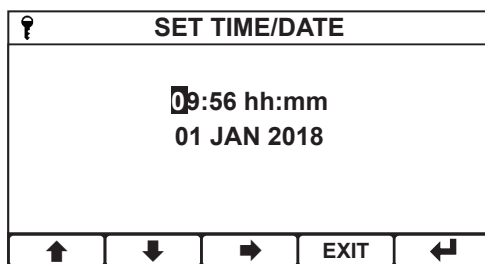

Set time and date

Sets the instruments time and date.

- ↑ / ↓ – Increase/decrease digit
- ➡ – Select next digit
- EXIT – Cancel
- ↵ – Save selection

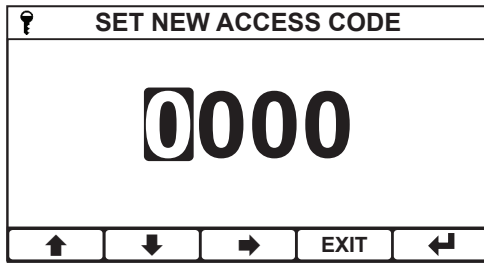

Set access code

Sets the security access code.

- ↑ / ↓ – Increase/decrease digit
- – Select next digit
- EXIT – Cancel
- ← – Save selection

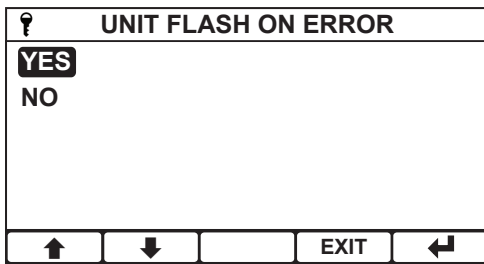

Unit flash on Error

Enables the display backlight from flashing in case of an instrument error.

- ↑ / ↓ – Select option
- EXIT – Return to main menu
- ← – Enter option

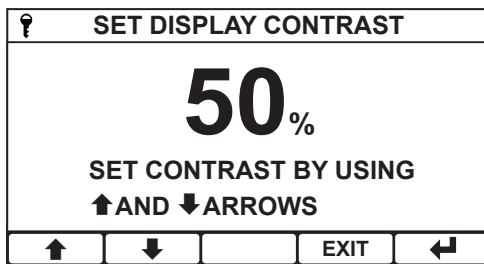

Set display contrast

Allows adjustment of the contrast of the display to compensate for environmental conditions that may affect its readability.

- ↑ / ↓ – Adjust contrast
- EXIT – Return to configuration menu
- ← – Enter option

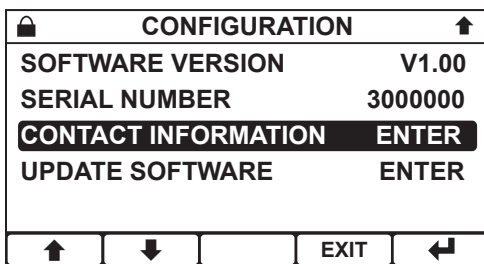

Software Version

Displays the instrument's current software version number.

- ↑ / ↓ – Select option
- EXIT – Return to main menu
- ← – Enter option

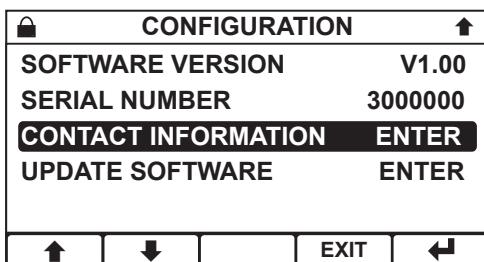

Serial Number

Displays the instrument's serial number.

- ↑ / ↓ – Select option
- EXIT – Return to main menu
- ← – Enter option

CONFIGURATION	
SOFTWARE VERSION	V1.00
SERIAL NUMBER	3000000
CONTACT INFORMATION	ENTER
UPDATE SOFTWARE	ENTER
↑	↓
	EXIT
	↵

Contact Information

Displays the contact information.

- ↑ / ↓ – Select option
- EXIT – Return to main menu
- ↵ – Enter option

5.8. Updating the software version

The ADCATrol BCS220 operating software can be upgraded by saving the latest version from Valsteam ADCA onto a micro SD card, inserting it into the instrument and following the instructions below. All three files must be present on the SD card for the update to work. The instrument supports SDHC and SDXC cards, however these must be formatted to fat32.

CONFIGURATION	
SOFTWARE VERSION	V1.00
SERIAL NUMBER	3000000
CONTACT INFORMATION	ENTER
UPDATE SOFTWARE	ENTER
↑	↓
	EXIT
	↵

Update software

Select the update software option from within the configuration menu.

- ↑ / ↓ – Select option
- EXIT – Return to main menu
- ↵ – Enter option

UPDATE SOFTWARE	
<p>ENSURE THE SD CARD REMAINS INSERTED & POWER TO THE UNIT IS NOT INTERRUPTED DURING THIS PROCESS.</p>	
<p>PRESS ENTER TO START</p>	
	EXIT
	↵

Update software

If the instrument has verified that all of the required software is present on the micro SD card press enter to begin the update.

During the update the display will indicate the progress of the update.

Once finished the instrument will restart automatically.

- ↑ / ↓ – Return to the update software menu
- ↵ – Begin update

5.9. Save, restore and factory reset

The ADCATrol BCS220 features the ability to save and restore the current configuration of the channel, setpoints, analog output, and digital inputs to one of two stores “Store A” and “Store B”. The save and restore menu also features the ability to reset the whole instrument back to its factory settings.

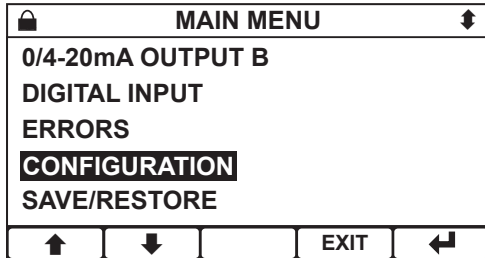

Main menu

From the front screen press the menu button to show the main menu options and select “Save/Restore”.

- ↑ / ↓ – Select option
- EXIT – Return to front screen
- ↵ – Enter option

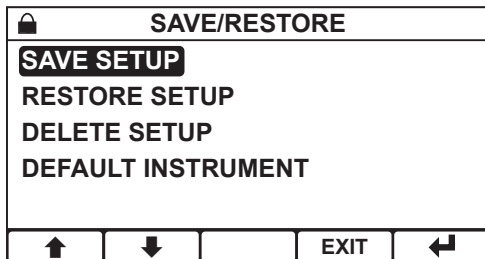

Save/Restore menu

Select the operation to be carried out.

- ↑ / ↓ – Select Option
- EXIT – Return to Main Menu
- ↵ – Enter Option

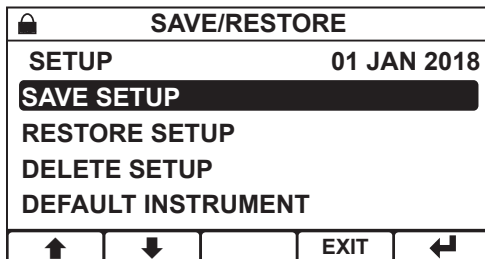

Save setup

Save the current instrument setup to either of the two stores.

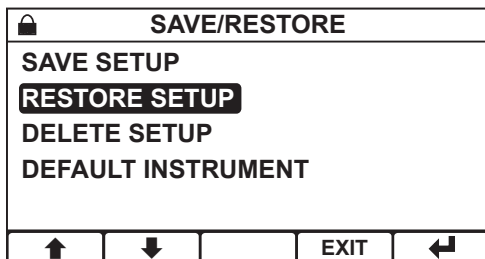

Restore setup

Restore either of the previously saved setups.

SAVE/RESTORE				
SAVE SETUP				
RESTORE SETUP				
DELETE SETUP				
DEFAULT INSTRUMENT				
↑	↓		EXIT	↩

Delete setup

Delete either of the previously saved setups.

SAVE/RESTORE				
SAVE SETUP				
RESTORE SETUP				
DELETE SETUP				
DEFAULT INSTRUMENT				
↑	↓		EXIT	↩

Default instrument

Reset the whole instrument back to its factory settings.

5.10. Service

The BCS220 features a service reminder system that will inform the user when the instrument is due its service.

SERVICE	
SERVICE REMINDER	YES
SERVICE INTERVAL	365 DAYS
NEXT SERVICE DATE	01 JAN 19
DEFER SERVICE DATE	7 DAYS
↑	↓
	EXIT
	↩

Service alarm

Service alarm configuration:

- Service reminder – Turn the service alarm on or off. Requires service security code prior to use.
- Service interval – Set the desired service interval. Requires service security code prior to use.
- Next service date – Sets the exact service date. Requires service security code prior to use.
- Defer service date – Only appears once the service interval has expired. Increases the service interval by an extra 7 days. Requires standard security code prior to use.

↑ / ↓ – Select option

EXIT – Return to main menu

↩ – Edit option

5.11. Commissioning examples

This section should aid the user during a first commissioning of an ADCATrol BCS220 controller, with some examples.

Before carrying out the following configuration settings ensure the unit is set with its factory settings. If unsure reset the unit back to its factory settings – see section 5.9 – Save, restore and factory reset.

For further information related to each of the controller functions, including their location within the instrument menus and how to set each one, see the sections above.

Example 1

System information:

- An ADCATrol SPS33 conductivity probe is directly connected to the shell of a boiler producing saturated steam at 10 barg (184,1 °C).
- The boiler manufacturer recommends a conductivity setpoint of 3000 µS/cm.
- A portable conductivity meter with a temperature compensation base of 20 °C is readily available. The instrument is calibrated.
- A relay output is to be set for monitorization purposes and set to energize as long as the conductivity is above the setpoint of 3000 µS/cm.

Commissioning procedure:

- In the “Channel” menu set “Temperature mode” to “TC IN Manual” and “Manual temp input” to “184.1”.
- Remove a sample of cooled boiler water and measure with the portable conductivity meter.
- In the “Calibration” menu enter “Sensor solution calibration” and adjust the reading to match the measured value.
- In the “Setpoint 1” menu set “Trigger” to “Latch high”, “Range” to “9999 µS/cm”, “Low value” to “2500” and “High value” to “3000”.
- In the “Setpoint 2” menu set “Trigger” to “High” and “High value” to “3000”.

Example 2

System information:

- An ADCATrol SPS21 conductivity probe is installed in the boiler blowdown line in series with an ADCATrol VPC26 TDS blowdown valve.
- The boiler is producing saturated steam at 10 barg.
- The boiler manufacturer recommends a conductivity setpoint of 2500 µS/cm. The

TDS blowdown valve is to open during 10 seconds every 30 minutes for sampling.

- An ADCATrol TRPT1 Pt100 temperature sensor is installed in the boiler shell for automatic temperature compensation of conductivity.
- An ADCATrol VPA26/2 Intermittent blowdown valve is installed and is to open during 2 seconds every 30 minutes.
- The boiler control panel features an output signal which closes during normal boiler operation and opens in case of stand-by and/or when the burner is switched off. This output is to be connected to the controller digital input to switch the controller between its "online" and "offline" state.
- A portable conductivity meter with a temperature compensation base of 20 °C is readily available. The instrument is calibrated.

Commissioning procedure:

- In the "Channel" menu set "Temperature mode" to "TC IN Pt100".
- Remove a sample of cooled boiler water and measure with the portable conductivity meter.
- In the "Calibration" menu enter "Sensor solution calibration" and adjust the reading to match the measured value.
- In the "Setpoint 1" menu set "Trigger" to "Blowdown high", "Sample time" to "00:10", "Cycle time" to "30:00", "Blowdown mode" to "Normal", "Low value" to "2000" and "High value" to "2500".
- In the "Setpoint 2" menu set "Trigger" to "Blowdown timer", "On time" to "00:02" and "Off time" to "00:30".
- In the "Digital input" menu set "Function" to "Offline" and "Polarity" to "Reverse".

6. TROUBLESHOOTING

i NOTE

There are no user serviceable parts inside the controller.

The ADCATrol BCS220 has been designed to include a wide range of self-diagnostic tests, some of which are performed at switch on, and some on a continuous basis. The following table provides a list of error codes generated by the instrument along with their probable causes.

Code	Possible cause	Corrective measure
Read/Write error E01	–	<ul style="list-style-type: none"> Switch the instrument off and then on again. If the message persists, contact Valsteam ADCA or its representative.
Data error E02	The instrument configuration has become corrupted.	<ul style="list-style-type: none"> Switch the instrument off and then on again. If the message persists, reset the unit back to factory settings – see section 5.9 – Save, restore and factory reset.
Storage error E03	The save setup configuration has become corrupted.	<ul style="list-style-type: none"> Switch the instrument off and then on again. If the message persists, reset the unit back to factory settings – see section 5.9 – Save, restore and factory reset.
Factory error E04	The factory configuration has become corrupted.	<ul style="list-style-type: none"> Switch the instrument off and then on again. If the message persists, contact Valsteam ADCA or its representative.
Calibration error E05	The user calibration has become corrupted.	<ul style="list-style-type: none"> Switch the instrument off and then on again. If the message persists, reset the unit back to factory settings – see section 5.9 – Save, restore and factory reset. If it recurs again contact Valsteam ADCA or its representative.
Sensor open circuit E21	The sensor input is at open circuit.	<ul style="list-style-type: none"> Check sensor conditions and connections. If the message message persists contact Valsteam ADCA or its representative.
Sensor short circuit E22	The sensor input is in short circuit.	<ul style="list-style-type: none"> Check sensor conditions and connections. If the message message persists contact Valsteam ADCA or its representative.
Sensor over range E23	The sensor reading is greater than the specified upper range limit.	<ul style="list-style-type: none"> Check “Channel” settings, sensor conditions and connections. If the message message persists contact Valsteam ADCA or its representative.
Sensor under range E24	The sensor reading is under the specified lower range limit.	<ul style="list-style-type: none"> Check “Channel” settings, sensor conditions and connections. If the message message persists contact Valsteam ADCA or its representative.
Temperature over range E31	The temperature sensor reading is greater than the specified upper range limit.	<ul style="list-style-type: none"> Check “Channel” settings, sensor conditions and connections. If the message message persists contact Valsteam ADCA or its representative.

Temperature under range E32	The temperature sensor reading is under the specified lower range limit.	<ul style="list-style-type: none"> Check “Channel” settings, sensor conditions and connections. If the message persists contact Valsteam ADCA or its representative.
Setpoint 1 sampling M53	The setpoint is in the sampling phase of the blowdown cycle.	–
Setpoint 1 blowdown M54	The setpoint is in the blowdown phase of the blowdown cycle.	–
Setpoint 1 cycling M55	The setpoint is in the cycling phase of the blowdown cycle.	–
Setpoint 1 triggered M91	Setpoint 1 has been triggered.	–
Setpoint 2 triggered M91	Setpoint 2 has been triggered.	
Analog output hardware error E61	The analog output circuit has detected an error in the analog output loop.	<ul style="list-style-type: none"> Check if the analog output loop is “broken” or if the load resistance is too large (maximum 750 Ω).
Sensor < Analog output “Zero” E62	The sensor input is below the analog output “Zero”.	<ul style="list-style-type: none"> Correct the analog output “Zero” function – see section 5.6 – Configuring the 0(4) to 20 mA analog output functions.
Sensor > Analog output “Span” E63	The sensor input is below the analog output “Zero”.	<ul style="list-style-type: none"> Correct the analog output “Zero” function – see section 5.5 – Configuring the 0(4) to 20 mA analog output functions.
Sensor > Analog output “Zero” E64	The sensor input is greater than the analog output “Zero”.	<ul style="list-style-type: none"> Correct the analog output “Zero” function – see section 5.5 – Configuring the 0(4) to 20 mA analog output functions.
Sensor < Analog output “Span” E65	The sensor input is below the analog output “Span”.	<ul style="list-style-type: none"> Correct the analog output “Zero” function – see section 5.5 – Configuring the 0(4) to 20 mA analog output functions.
Service due M80	The planned service interval has expired. Contact Valsteam ADCA or its representative.	<ul style="list-style-type: none"> Contact Valsteam ADCA or its representative.
Calibration due M81	The user entered calibration interval has expired.	<ul style="list-style-type: none"> Proceed accordingly.
“Service mode” is active	The instrument is in “Service mode” and as such the setpoints and analog output may not respond as configured.	<ul style="list-style-type: none"> Contact Valsteam ADCA or its representative.

If the unit is malfunctioning and not displaying an error message check the table below which lists various malfunctions and applicable corrective measures. If the issue cannot be solved with the help of the following table, contact VALSTEAM ADCA or its representative.

Malfunction	Corrective measure
<p>The instrument does not turn ON.</p>	<ul style="list-style-type: none"> • Check that power is available to the unit. Using a voltmeter, set to AC or DC, check the power supply voltage at the connector. • The BCS220 allows the unit to accept from 90 to 265V AC and the BCS220-LV will accept 12 to 30V DC, check the connection label for voltage specification. • Check that the power wires are correctly connected. There are no user serviceable fuses fitted within this unit.
<p>The access code does not work</p>	<ul style="list-style-type: none"> • It is probable that the access code has either been changed or the operator does not recall the code correctly. Contact Valsteam ADCA or its representative.
<p>The conductivity reading is constantly over range or under range</p>	<ul style="list-style-type: none"> • Ensure that the conductivity probe and temperature sensor are correctly connected and are not faulty or damaged– see sections 4.3.4 and 4.3.5. • Check the conductivity probe and its cable for possible short circuits. Consider the fact that the conductivity may be higher than the range of the instrument. • Check that the conductivity probe is “seeing” a representative sample. Trapped air or steam will display an under-range reading. • Check that the correct “Range” has been selected within the “Channel” menu. If in doubt set to “Auto Range”. • Check that the correct “Cell Constant” has been selected within the “Channel” menu. If calibration of the instrument is not being carried out through setting of the cell constant, set it to “1”. • Check the “Temperature mode” and if set to “Manual” ensure that the fixed temperature is at the correct level. If the compensation is “TC IN PT100” or “TC IN PT1000” check that the temperature reading on the main display is correct. • Ensure the system, including all components such as sensors, valves and fitting, are correctly installed and have been selected in accordance with the application in hands. Contact Valsteam ADCA or its representative.
<p>The display reads zero</p>	<ul style="list-style-type: none"> • Check for open circuit sensor (conductivity or TDS modes). • Check for short circuit sensor (resistivity mode). • Check for damage to the connecting cables. • Check for contamination of the conductivity probe electrode(s). • Ensure that the conductivity probe and temperature sensor are correctly connected and are not faulty or damaged– see sections 4.3.4 and 4.3.5. • Check that the conductivity probe is completely immersed in a representative sample. Trapped air or steam will display an under-range reading. When using an ADCATrol SPS33 conductivity probe, directly installed in the steam boiler, ensure it is fitted in a way that it is always in contact with the water (immersed at least 100 mm), away from the steam bubbles, and as far from the feedwater inlet as possible. • Ensure the system, including all components such as sensors, valves and fitting, are correctly installed and have been selected in accordance with the application in hands. Contact Valsteam ADCA or its representative.
<p>Instrument display appears to malfunction</p>	<ul style="list-style-type: none"> • Switch the instrument power off and on again. • Check that the display backlight is on, indicating power is reaching the unit. • See that it displays meaningful text in its start-up sequence, indicating processing activity.

<p>The conductivity reading is incorrect</p>	<ul style="list-style-type: none"> • In case of a low reading check for contamination of the sensor electrode(s). • Check that the sensor is completely immersed in a representative sample. Trapped air or steam will display an under-range reading. When using an ADCATrol SPS33 conductivity probe, directly installed in the steam boiler, ensure it is fitted in a way that it is always in contact with the water (immersed at least 100 mm), away from the steam bubbles, and as far from the feedwater inlet as possible. • If the conductivity probe is fitted with an outer shroud ensure there are no foreign particles trapped inside it. If the openings holes on the top section of the outer shroud are clogged, air will stay trapped inside and the unit may display a low conductivity reading. Clean and test. • High conductivity readings can be caused by internal short circuit due to leakage of medium/contaminants into the conductivity probe housing. Replace the conductivity probe. • The sensor should be checked, when dry, with an ohmmeter. Disconnect it at the controller end and check the resistance between terminals "E" and "C" as well as the leakage from terminals "E" and "C" in turn to the cable screen. It should be greater than 50 MΩ in any case. • Check that the temperature resistance is correct, otherwise the temperature compensation circuit will cause false or erratic readings. Temporarily switching off the temperature compensation can help understand if this is the cause of the malfunction. • If another conductivity sensor is available, this can be used to determine whether the fault lies within the instrument or the sensor. • Check that the sensor cable is not damaged or broken and that the outer screen does not make contact with any other terminals or metal work. • Check that the inner screen "G" does not contact any other terminals or metalwork at the sensor end. It should not be grounded. • Check that the sensor cable is sufficiently distant from power cables or electrical noise sources. • Check that a correct conductivity probe has been installed according to the application and the solution conductivity range. • Check that the correct range has been selected. • Check that the correct sensor calibration values have been used. • Check that the calibration procedure has been followed precisely.
<p>The temperature reading is incorrect</p>	<ul style="list-style-type: none"> • Ensure that the temperature sensor is correctly connected and is not faulty or damaged—see section 4.3.5 – Connecting the temperature sensor. • Check that the temperature sensor type is correctly selected in the "Channel" menu. • Where practical check the temperature sensor resistance and compare to the respective approximate resistance values of temperature sensors. Example: Temperature of 0 °C should correspond to 1000 Ω on a Pt1000 and 100 Ω on a Pt100. Temperature of 100 °C should correspond to 1385 Ω on a Pt1000 and 138,5 Ω on a Pt100.
<p>Analog output is incorrect or noisy</p>	<ul style="list-style-type: none"> • Check that the maximum load of the current loop has not been exceeded (750 Ω). • Check that the terminals have been wired correctly. • Check that the cable screen is connected to Earth at one end and that the cable does not pass too close to a power cable. • Check that the analog output has been properly configured.
<p>Relays appear to malfunction</p>	<ul style="list-style-type: none"> • Check that the unit is "Online". • Check that the setpoint has been configured properly. • If the relays are vibrating or "chattering" as they activate, check the hysteresis setting and increase if necessary. • Ensure that the relays are connected properly and that the voltage/current levels are not exceeding 5A @ 30V DC or 5A @ 250V AC. • Check that the instrument input cables are not picking up excessive noise.

7. DISPOSAL

As per directive 2012/19/EU, once the product has reached the end of its working life, it should be sent for disposal in accordance with the prevailing national and local regulations concerning the disposal of waste electrical and electronic equipment.

8. RETURNING PRODUCTS

Information regarding hazards and precautionary measures to be considered due to contaminating fluids and residues or mechanical damage that may represent a health, safety or environmental risk, must be provided in writing when returning products to VALSTEAM ADCA.



WARNING

RISK DUE TO PRESENCE OF HAZARDOUS RESIDUES ON RETURNED PRODUCTS

Contaminated fluids and residues may represent an environmental risk, or risk to VALSTEAM ADCA personnel.

- Information regarding any hazards or precautionary measures to be considered must be provided in writing when returning products to VALSTEAM ADCA.
- Health and Safety information sheets relating to any substances identified as hazardous or potentially hazardous must be provided outside the packaging.
- Use Hazmat labels on the packaging.

IMPORTANT NOTE

Total or partial disregard of these Installation and Maintenance Instructions involves loss of any right to warranty.

The extent and warranty period are specified in the “General sales conditions”.